

# family handyman

SMART HOME IMPROVEMENT™



DO-IT-YOURSELF

## MODERN FOUNTAIN

BUILD IT IN A WEEKEND!

VERTICAL GARDENING FOR SMALL SPACES

SETTING FENCE POSTS THE EASY WAY

EARTH-FRIENDLY WEED CONTROL

SELF-CLEANING OVENS:  
ARE THEY SAFE?  
P. 58



MAKE YOUR OWN HYDROPONIC GARDEN



# COUNTRY HOME PRODUCTS®



**FREE**  
**SHIPPING**  
Limitations Apply

Products for property care & outdoor life

**CHP.com**

**TAKE 10% OFF YOUR 1ST ORDER!**

Use **CODE: Welcome10**

# YOU'VE INSPIRED US!

WHAT'S YOUR NEXT PROJECT?

**W**hen I think about spring, what comes to mind is growth. New life. Rejuvenation. And projects. For me, this is the most motivating season to decide which projects to tackle both inside and outside my home.

Every spring, my family tries to complete at least one project together. It's not always easy to find the time with the chaos of everyday life: Work, school, sports and other commitments keep us plenty busy. But it's important to us to prioritize one project, whether it be creating a simple birdhouse, staining our deck or building raised bed gardens. I value the time we spend creating things—and memories—together.

Of course, projects aren't just built in the spring. Last winter, we invited all of you to show us what you were creating through our Holiday Spirit Contest. We received hundreds of submissions, and we had a lot of fun looking through them to pick the winners. Congratulations to Joanne Grant, Chase Young, Jason Adamson and honorable mention O.J. Vallejo for their standout work.

And now we're excited to share their projects with all of you! Scan the QR code for a look at more contest entries. We love seeing all of your creative work in any season, so please keep sending it our way at [submissions@familyhandyman.com](mailto:submissions@familyhandyman.com).

Best of luck with your building, planting and all things spring!

**AMY NOVAK**  
CONTENT DIRECTOR



**JOANNE GRANT**  
WINNER, EDITORS' CHOICE

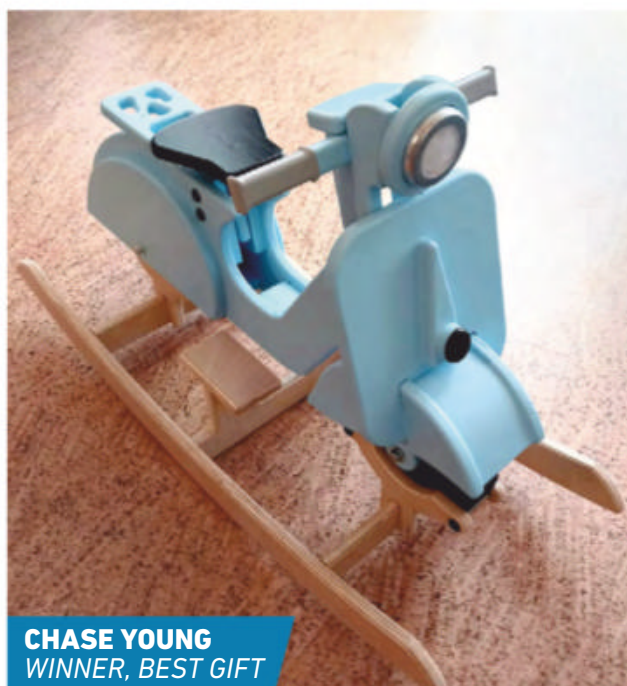

**CHASE YOUNG**  
WINNER, BEST GIFT



**JASON ADAMSON**  
WINNER, BEST DECORATION



**SCAN THIS CODE TO SEE MORE OF OUR READERS' BEST PROJECTS.**



**O.J. VALLEJO**  
HONORABLE MENTION

PHOTOS: JOANNE GRANT, CHASE YOUNG, JASON ADAMSON, O.J. VALLEJO



## DEPARTMENTS

**8 HANDS ON**  
A battery-powered auger, a timesaving mower, and more stuff we love.

**12 HANDY HINTS®**  
Check out the convenient extension cord carrier made from a bucket.

**50 BEST PRO TIPS**  
Ready to hit the road? Seven bike maintenance tips to keep you pedaling.

**56 HOME CARE**  
Setting fence posts with expanding foam, and facts about self-cleaning ovens.

**60 READER INFO**  
Find out how to subscribe, renew, send us a hint and so much more.

**64 GREAT GOOFS®**  
The good news is the deer aren't munching on the new shrubs anymore. The bad news is ...

36

## FEATURES

**16 MODERN WATER FOUNTAIN**  
We all need a calming oasis in our backyard right now.

**24 VERTICAL GARDEN**  
Short on growing space? Go up!

**30 GROW MINI VEGETABLES**  
Homegrown taste from easy-to-handle compact plants.

**36 HYDROPONIC GARDEN**  
Build this setup to have fresh produce at your fingertips.

**43 EARTH-FRIENDLY WEED KILLERS**  
Simple, nontoxic ways to get rid of unwanted plants in your yard.

**46 PEBBLE MOSAICS**  
Make your own beautiful steppingstone pathway!

# WHAT'S NEW?

facebook.com/thefamilyhandyman  
pinterest.com/family\_handyman  
youtube.com/thefamilyhandyman  
instagram.com/familyhandyman  
tiktok.com/@familyhandyman



## READER EMAIL

Bill Peros of Mashpee, Massachusetts, said he was excited to see the greenhouse plans in our Sept. 2022 issue. He had built one of his own design in April 2020.

Peros said that when the weather warmed up, "I quickly realized that a roof vent window was needed in addition to the gable vents; otherwise, the greenhouse got too hot. So I cut in a roof window between two rafters, hinged a framed window and installed a Palram Automatic Roof Vent Opener (about \$70). As the temperature nears 70 degrees, a liquid in the opener's cylinder expands, causing the vent to open. As the temperature drops, the vent closes. The opener requires no power and has worked perfectly for over two years. I hope you can share this with your readers as an easy add-on to your greenhouse plans."

## MEET THEA ALVIN, STONEMASON

When spring finally hits here in Minnesota, our thoughts turn to outdoor projects.

Who better to inspire us than Thea Alvin, one of the world's foremost dry-stacking stonemasons? She's featured at [familyhandyman.com](https://familyhandyman.com) in our series about the women who make up 11% of the construction workforce in the U.S.

Alvin has been working as a stonemason for nearly 40 years, starting at 16 when she helped her father mix mortar and carry bricks. "Stone masonry as a career came as a result of loving being outside, of the challenge of the paradox of me doing it," she says.

Alvin has worked on chapels, walkways and water features. She rebuilt a 15th-century-style domed Trulli house in Southern Italy and crafted a cistern in an upscale Colorado yard.

One of Alvin's favorites is a labyrinth she and her team of 11 built in Tennessee in September 2021. "It was the biggest of my career and easily the most beautiful. It was 150 feet across, with some walls being 12 feet tall. On the autumnal equinox, the light comes through the archway door."

As a woman in the trade, Alvin says she has a feminine perspective. "I think the way I look at life is demonstrated in my style of walling: extremely forgiving and accepting. I love being an imperfectionist and supporting other folks to accept their own flaws."

To read more of Karuna Eberl's interview with Thea Alvin, hop over to our website and search for Alvin's name. And if you know someone we should feature, please email us at [submissions@familyhandyman.com](mailto:submissions@familyhandyman.com).



### THE DIY ADVICE WE ALL NEED

Get more than 700 DIY projects, repairs and tips in just one volume. You'll find the step-by-step info you need to repair, maintain and improve your home. It's \$10 and shipping is free. [familyhandyman.com/2UND](https://familyhandyman.com/2UND)



# Do it Right with DR®

## Devour Brush Piles with a DR® Chipper Shredder!

★ USA

ENGINEERED AND BUILT

Assembled in the USA using domestic and foreign parts.



- CHIP & SHRED with power to spare
- BIGGER ENGINES beat the competition
- BUILT USA TOUGH for smooth operation
- Easy to maneuver and EASY ON YOU

[DRchipper.com](http://DRchipper.com)

## Make Your Driveway Like NEW with a DR® Power Grader!



- Fill in potholes & smooth out washboard
- Loosen & redistribute existing material
- Tow with your ATV, UTV, or tractor



[DRpowergrader.com](http://DRpowergrader.com)

**SALE!**

**FREE SHIPPING**

SOME LIMITATIONS APPLY

**DR Power Equipment**

A GENERAC POWER SYSTEMS COMPANY

# Nothing Stops a DR® Field & Brush Mower!

★ USA  
ENGINEERED AND BUILT

Assembled in the USA  
using domestic and  
foreign parts.

Starting at Just  
**\$1999<sup>99</sup>**



## The LEADER in Field & Brush Mowers

- Up to 2X THE POWER of the competition
- CUT 3" brush & thick field grass with ease
- WIDEST SELECTION of deck sizes and features
- GO-ANYWHERE power steering & hydrostatic drive options

[DRfieldbrush.com](http://DRfieldbrush.com)



**PLUS**

Tow-Behind, Commercial & NEW ELECTRIC models

## Great Gardens Start with DR® Rototillers!



- Bust sod and churn through the most compacted ground
- Prepare seedbeds or till garden waste back into your soil
- Full line includes walk-behinds, tow-behinds, and cultivators



[DRrototiller.com](http://DRrototiller.com)

Request your FREE PRODUCT CATALOG  
Online or Toll-Free at 800-456-2068

**GoDRpower.com**





# Do it Right with DR<sup>®</sup>

## Discover the **POWER** and **PRECISION** of a DR<sup>®</sup> Trimmer Mower!

- 5X the power of a handheld trimmer
- TRIM precisely without arm fatigue
- MOW where a bladed mower can't
- TOUGHEST trimmer cord available



★ **USA**  
ENGINEERED AND BUILT

Assembled in the USA using domestic and foreign parts.

[DRtrimmer.com](http://DRtrimmer.com)

## The **LEADER** in Leaf Vac's!

**NEW DESIGN**



## DR<sup>®</sup> Leaf & Lawn Vacuums



**EASY 1-hand dumping!**

### Tow-Behind

- #1 in vacuum power and capacity
- **NEW PRO MAX** model holds up to 450 gallons
- All models newly redesigned with up to 20% more capacity

### Walk-Behind

- **NEW PILOT XT** models fill paper leaf bags for curbside pickup
- Collects & mulches up to 50 lbs of leaves
- Includes onboard caddy for extra bags



★ **USA**  
ENGINEERED AND BUILT

Assembled in the USA using domestic and foreign parts.

[DRleafvac.com](http://DRleafvac.com)

**SALE!**

**FREE SHIPPING**

SOME LIMITATIONS APPLY

**DR Power Equipment**

A GENERAC POWER SYSTEMS COMPANY

**Make Stumps  
Disappear!**



- Grind away stumps fast
- Rotary head takes 360 “bites” per second
- Tungsten carbide-tipped teeth
- Self-propelled available

**★ USA**  
ENGINEERED AND BUILT

Assembled in the USA using domestic and foreign parts.



[DRstumpgrinder.com](http://DRstumpgrinder.com)

**Haul up to 800 lbs with  
a DR® Powerwagon!**



- Self-propelled hauler
- Powers up hills with ease
- Powered dumping
- Converts to a flatbed

**★ USA**  
ENGINEERED AND BUILT

Assembled in the USA using domestic and foreign parts.



[DRpowerwagon.com](http://DRpowerwagon.com)

**BURN SAFELY with  
the DR® BurnCage™**



- Stainless steel design
- Light, durable portable, folds flat for storage
- Perforated construction maximizes airflow
- Traps embers and burns more thoroughly

**Available  
in 3 sizes**

**BurnCage™**

**MAX**

**2X**  
the Volume  
of the  
Original!



[DRburncage.com](http://DRburncage.com)

Request your **FREE PRODUCT CATALOG**  
Online or Toll-Free at 800-456-2068

**GoDRpower.com**



# HANDS ON

**fh** TOOLS, GADGETS + GEAR WE RECOMMEND

## NO-GAS AUGER

I rebuilt my backyard fence last summer and needed the posts closer together. This meant digging all new post-holes. If I'd had only a few holes to dig, I'd have done them by hand, but I had to dig about 20. I didn't have room to bring in a skid steer, but I did have Ryobi batteries from other yard tools I own, so I grabbed a Ryobi 8-in. 40-volt battery-powered auger.

My expectations were low, so I was happily surprised when this auger bored into the dirt with the ease of a gas-powered machine. The auger will stop if you hit a large rock, but if you hit a rock with a gas-powered auger, you get flung like a rag doll—so I don't mind the auger stopping in this case.

Also, as with any powered, hand-operated auger, you do need to lift it out of the ground. But it's still much easier than digging all those holes by hand. You can pick up the 40-volt posthole auger online or at home centers for \$500—this includes the tool, a 40-volt battery and a charger. 

**BRAD HOLDEN** DEPUTY PROJECT EDITOR

# POCKET-SIZE LASER MEASURER

**T**he Craftsman Pocket Laser Distance Measurer is capable of measuring distances up to 55 ft., accurate to within  $\frac{1}{4}$  in. With a single button, the  $1\frac{1}{2}$  x  $2\frac{1}{2}$ -in. unit shoots a red laser at targets to determine their distance. It's as simple and foolproof as it gets. As soon as I took it out of the package, I was shooting measurements. And it features a micro-USB rechargeable lithium-ion battery. The Craftsman Pocket Laser Distance Measurer lets you pick from inches, feet and inches, feet as decimals, or meters as decimals.

To determine accuracy, I took some measurements around the house with a 30-ft. tape measure, a 100-ft. fabric tape measure and the Craftsman Pocket Laser Distance Measurer. I performed a side-by-side comparison of 50 measurements taken with the Craftsman Pocket Laser Distance Measurer and the tape measures.

It was spot on 27 out of 50 times. The other 23 times, the average discrepancy was .146 inches, or a bit over  $\frac{1}{8}$  in. I assumed the laser distance measurer and tape measures would differ most at longer distances, but that wasn't the case. Discrepancies were between  $\frac{1}{16}$  in. and  $\frac{3}{16}$  in. and came at many distances—from less than 4 ft. to more than 45 ft. A  $\frac{1}{4}$ -in. discrepancy was rare at any distance.

You can spend hundreds of dollars on laser measurers that will give you better precision, but the Craftsman Pocket Laser Distance Measurer is perfect for “close enough” measurements or calculating estimates—for flooring or paint quantities, for example. The Craftsman Pocket Laser Distance Measurer is available at home centers for about \$35. 

**MIKE BERNER** SENIOR PROJECT EDITOR



## PORTABLE COOL

Living in Minnesota, I dread four or five weeks each year: a few weeks in the winter that are unbearably cold, and a week or two in the summer when temperatures push 100 degrees and I break into a sweat retrieving the morning paper. With the Arctic cold, I can always layer up. But during a heat wave, options are fewer.

Last summer I decided to try out a portable air conditioner at our cabin. The LG 7,000 BTU Portable Air Conditioner is a standalone AC, dehumidifier and fan in one. It features multiple fan speeds, an on/off timer and an auto restart feature for power outages. The large digital user-friendly dashboard features indicator lights for fan speed, timer and temperature control. The AC also features an innovative auto-swing vent to circulate the cool air.

Maintenance is simple. First, a light indicates when it's time to clean two air filters. You just pop them out, rinse, dry and reinstall. Second, two spigots on the back of the machine drain condensation from the air conditioner and dehumidifier. Make sure to connect a drain hose or empty them regularly.

Once installed at our cabin, the LG Portable Air Conditioner did an adequate job of slowly cooling the large living area, which is almost double the recommended square feet for this unit. At night, we rolled the machine into the bedroom. I had to reinstall the venting in a bedroom window, but the unit kept us cool and comfortable in the small area. The LG 7,000 BTU Portable Air Conditioner (\$400) is available at The Home Depot, Lowe's, Amazon and LG.com. 

**ETHAN O'DONNELL** EDITOR

## HANDS ON



### REFRESH DIM HEADLIGHTS

**T**he 3M Restore and Protect Headlight Restoration Kit claims to make your headlights 10 times clearer, improve brightness by up to 200% and add a layer of UV protection. The two-step kit includes an instruction pamphlet, 1,000- and 3,000-grit refining discs, a foam sanding pad, a couple of clear coat wipes and one disposable glove.

My car's lights were in good shape, so I tested the kit on a couple of junkyard headlights. I started by cleaning the headlights with soap and water. Next, I attached the P1000 abrasive disc to the pad and started sanding. Using a spray bottle, I wet the headlight and sanding disc liberally. I attacked the headlight with plenty of elbow grease, sanding vigorously and spritzing with water as needed. With the P1000 disc, the goal is to remove yellowing, pitting and surface defects from the lens. Each lens needed two to three minutes to take off all the discoloration and defects.

Then I switched to the P3000 disc and repeated the process, dampening the disc and lens as I worked. Once I finished sanding both lights, I wiped down the headlights with a clean towel and water. The yellowish color was gone, but the headlights still looked cloudy.

The next step—wiping on the clear coat—took care of that, making the lenses look like new. I let the first clear coat dry for 15 minutes, then I applied the second coat. It took about 10 minutes to restore each headlight. The 3M Restore and Protect Headlight Restoration Kit is available online for about \$13. 

JAY CORK PROJECT EDITOR 



### GRILLING BASKET

The Weber Deluxe Grilling Basket is a stainless steel container available in two sizes: small, 7½-in. square, or large, roughly 11 x 13 in. Both basket sizes are a hair under 2½ in. deep and can be used with gas, charcoal or pellet grills.

These baskets are ideal for grilling vegetables and bite-sized items such as shrimp or steak tips. They have easy-to-grab handles and they're dishwasher safe. The small and large sizes of the Weber Deluxe Grilling Basket are available for \$25 and \$35, respectively, at home centers or online. 

ETHAN O'DONNELL EDITOR

### TIMESAVING MOWER

After researching wide, homeowner-grade, walk-behind mowers, I decided on the Toro TimeMaster 30. This 30-in.-wide walk-behind mower is powered by a 223cc Briggs & Stratton gasoline engine. The 30-in. cutting deck has two 15-in. blades.

The mower has a few nice features: an easy two-point lawn height adjustment, a quick-stow storage lever and an automatic blade-stop system so you can move an obstacle without turning off the mower. An innovative Personal Pace self-propelled system senses your preferred walking pace and adjusts the mower speed accordingly. And when it's time to tidy up, a built-in washout port for a hose connection simplifies cleaning the underside of the mowing deck.

The mower comes assembled and includes a grass collection bag, a detachable side discharge chute, a garden hose attachment for the washout port and a quart of engine oil.

The Toro TimeMaster 30, with a 30-in. cutting deck, costs \$1,500. Toro backs all its mowers with a three-year, guaranteed-to-start warranty. The TimeMaster 30 is available with a push-button start, but I chose a pull start. Find yours at a home center or hardware store. 

ETHAN O'DONNELL EDITOR





# On The Trail Of LEWIS & CLARK

## COLUMBIA AND SNAKE RIVERS

Follow Lewis and Clark's epic 19th-century expedition along the Columbia and Snake Rivers aboard the newest riverboats in the region. Enjoy unique shore excursions, scenic landscapes, and talented onboard experts who bring the region to life.

*Cruise Close To Home®*

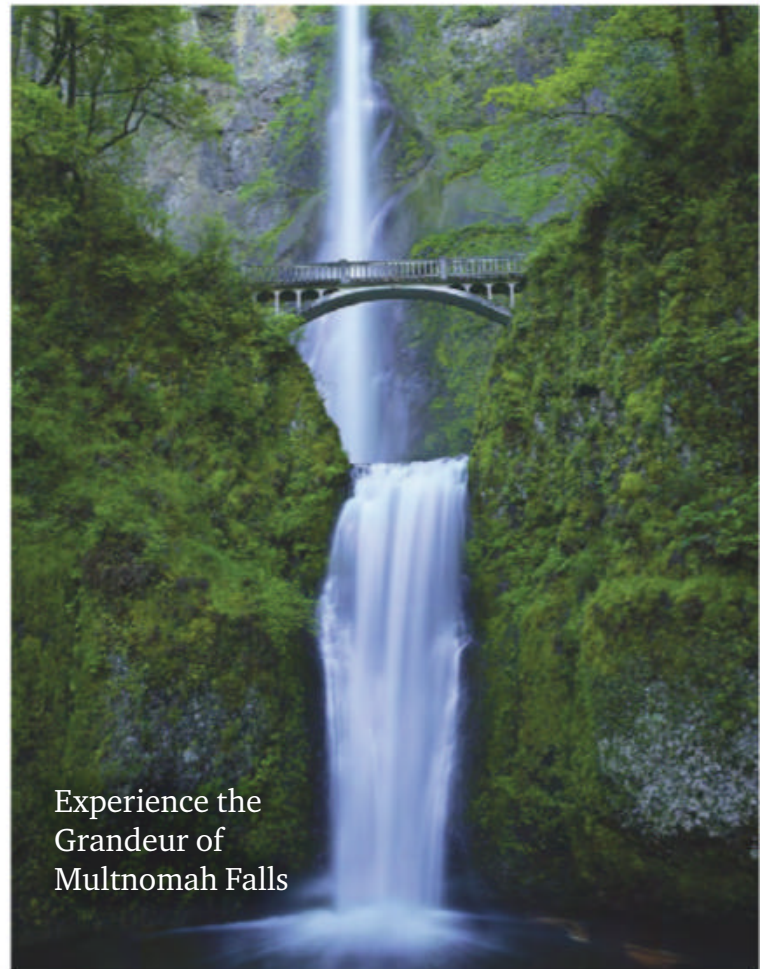

Experience the Grandeur of Multnomah Falls



Call

**866-975-1647**

to request a

★ **FREE** ★

Cruise Guide

[AmericanCruiseLines.com](http://AmericanCruiseLines.com)

# HANDY HINTS



CLEVER SOLUTIONS FROM OUR READERS

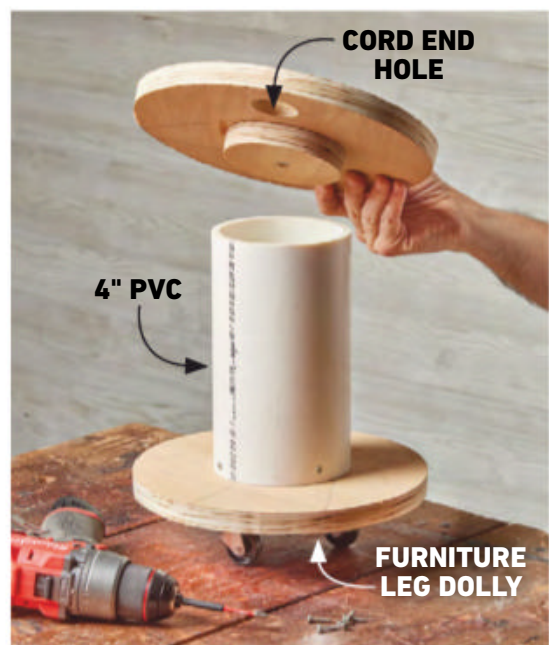

## DRILL-POWERED CORD STORAGE

I made this cord reel to easily roll up and store long extension cords using a 5-gal. bucket, plywood scraps, a 12-in. length of 4-in. PVC pipe and a furniture leg dolly. I cut two plywood discs to fit inside the bucket and two to fit inside the pipe. Glue the small discs in the center of each large disc. Slip on the pipe and secure it with a few screws. Attach the dolly to the bottom, set the reel in the bucket and cut a hole on the side. To reel in the cord, drive a lag screw in the top of the reel and let the drill do the work.

MIKE BERNER



## INSTANT TOOL HOLDER

**H**ere's how I store files, large drill bits, screwdrivers and other long tools so they're easy to see and close at hand. Cut the top off a clear 2-liter plastic soft drink bottle, leaving a flap for hanging. Smaller bottles hold smaller tools and common household items.

**NOEL HANSEN**

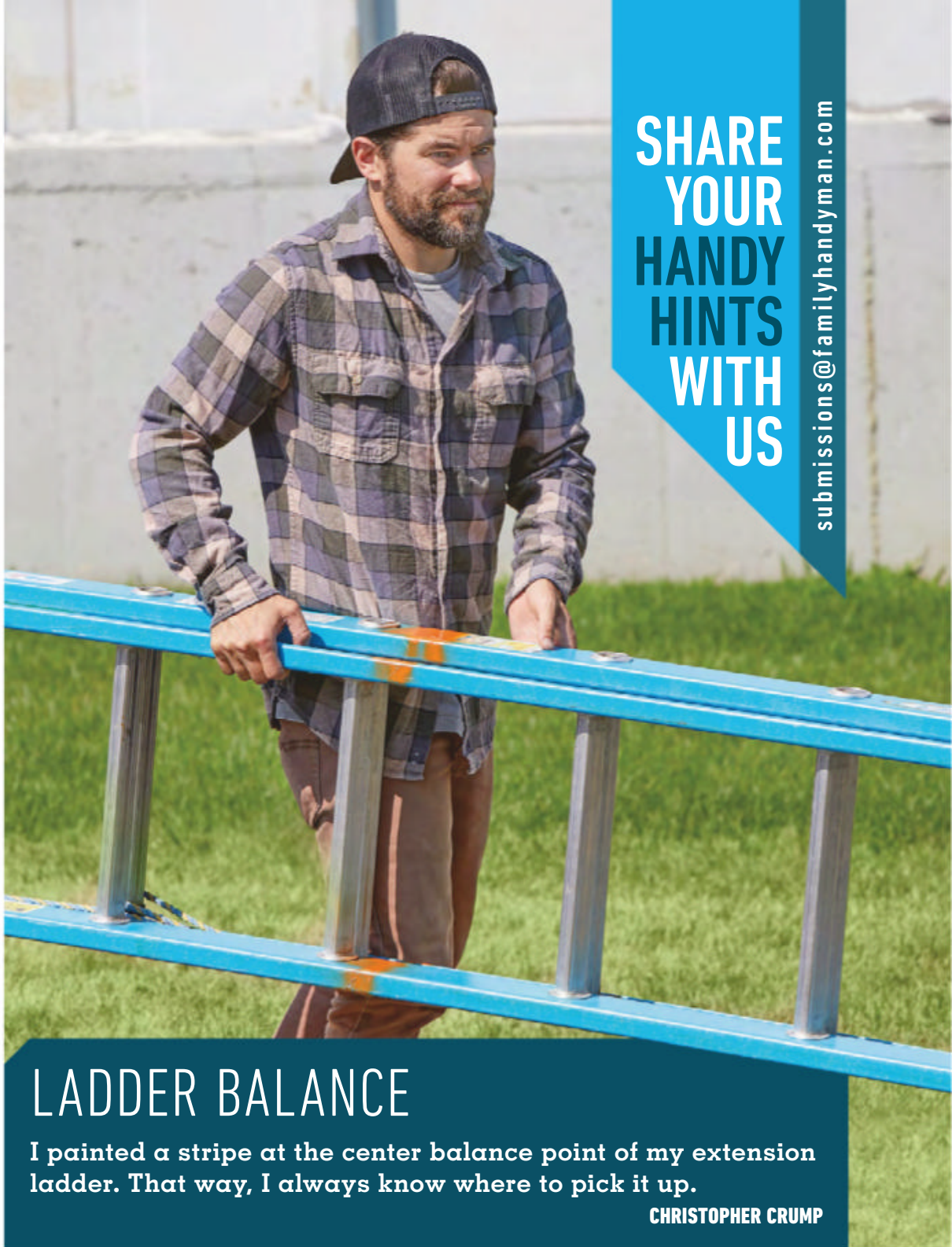

**SHARE  
YOUR  
HANDY  
HINTS  
WITH  
US**

[submissions@familyhandyman.com](mailto:submissions@familyhandyman.com)

## LADDER BALANCE

I painted a stripe at the center balance point of my extension ladder. That way, I always know where to pick it up.

**CHRISTOPHER CRUMP**

## ON THE MARK

Make an accurate cutting line for PVC pipe by cutting a 2-in. piece from the factory-cut end of the pipe. Cut a slit through the piece so it can easily be slipped onto the section being cut. Use the factory-cut edge to mark, or as a guide for your handsaw.

**DENNIS H. SHIELDS**

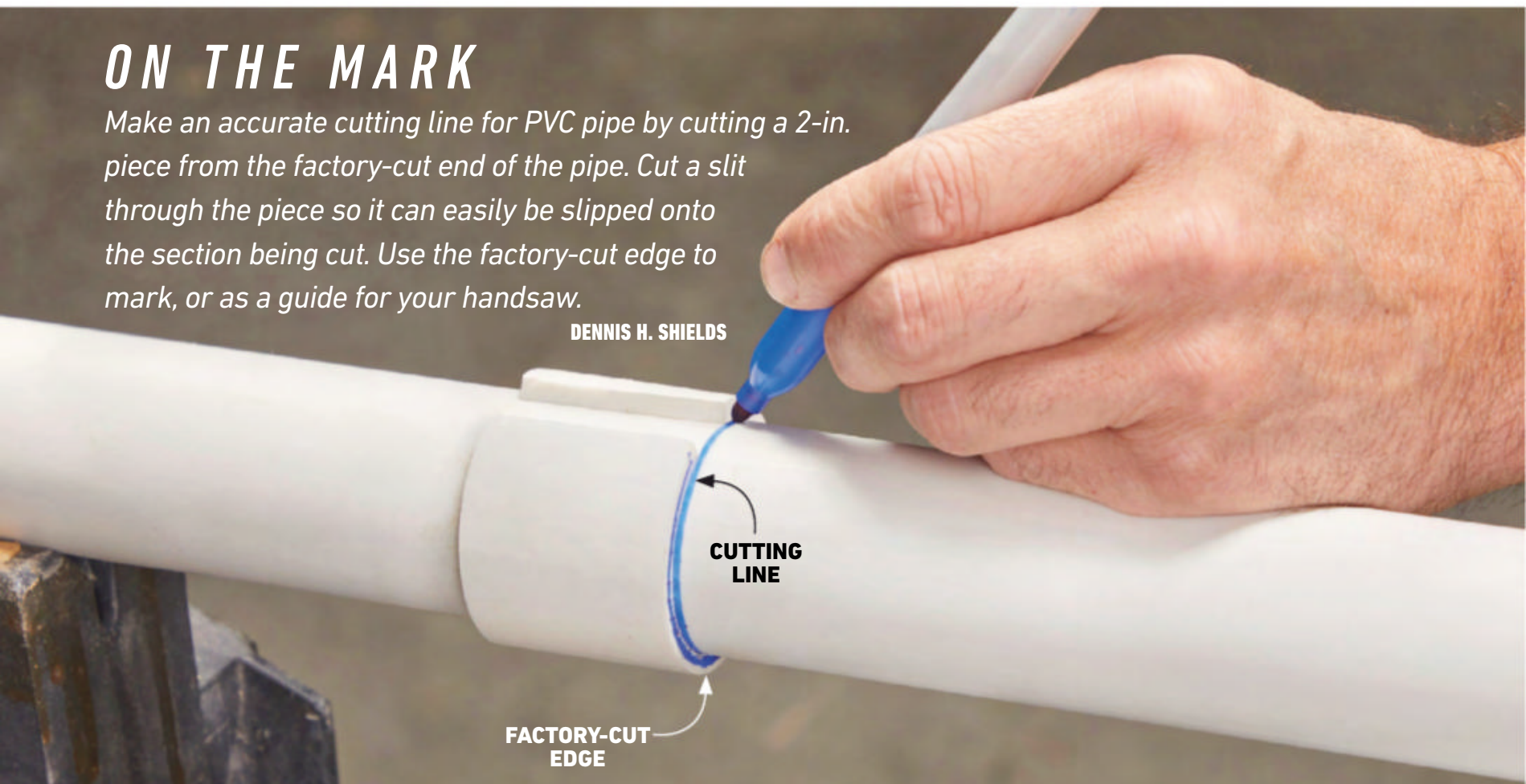



## ADJUSTABLE DRAWER DIVIDER

*The utensil tray in our kitchen drawer would slide around and get out of place, occasionally spilling flatware. So this was my easy fix: I fit a piece of 1/4-in. plywood between two strips of adhesive-backed foam—one at the back of the drawer and one at the front. The tray stays put, and the divider makes another usable space for long utensils. The divider is easy to move as needed.*

**MIKE BERNER**



## CORD AND HOSE HANGERS

**S**ave plastic six-pack rings to hang cords, ropes and air compressor hoses. Fold over the plastic holder to make a three-ring strip, then slide one end through the other—around the cord or hose—and hang it on a nail or peg.

**DON RUGGIERI**



## AT THE END OF YOUR ROPE?

Here's a smart way to keep nylon rope from fraying when you cut it. Firmly wrap three turns of electrical tape around the rope and cut it with a sharp utility knife. Keep the tape around the end and melt the end of the rope slightly with a lighter. The tape keeps the braided nylon from turning into a melted blob.

**TIM KING** 



# BACK-BREAKING WORK REQUIRES SOME HELP

Everyone feels the hurt as you age, but CBD can help you deal with it

By: Beth Giles

Life really does fly by. Before I knew it, my 60s had arrived, and with them came some new gifts from dear ol' Mother Nature—frequent knee pain, stress, low energy and sleeplessness. Now, I'm a realist about these things, I knew I wasn't going to be young and springy forever. But still, with "golden years" nearly on my doorstep, I couldn't help but feel a little cheated. That is until I found my own secret weapon. Another gift from Mother Nature.

It began a few months back when I was complaining about my aches and pains to my marathon-running granddaughter, Jen. She casually mentioned how she uses CBD rub to help with her joint pain. She said that CBD gave her more focus and clarity throughout the day and that her lingering muscle and joint discomfort no longer bothered her. She even felt comfortable signing up for back-to-back marathons two weekends in a row this year. That made even this self-proclaimed skeptic take notice.

But I still had some concerns. According to one study in the *Journal of the American Medical Association*, 70% of CBD products didn't contain the amount of CBD stated on their labels. And, as a consumer, that's terrifying!

If I was going to try CBD, I needed to trust the source through and through. My two-fold research process naturally led me to Zebra CBD.

First, I started calling my family and friends. Call me old fashioned but I

wanted to know if there were people whom I trusted (more than anonymous testimonials) who've had success using CBD besides my granddaughter.

Secondly, I wanted cold hard facts. Diving deep into the world of CBD research and clinical studies, I came across Emily Gray M.D., a physician at the University of California at San Diego (UCSD) Medical School and medical advisor to Zebra CBD who is researching the effects of CBD. Dr. Gray wrote "early results with CBD have been promising and we have a lot of research underway now. I've had several patients using CBD with good success. It's important that you know your source of CBD and how to use it properly."

After hearing it from the doctor's mouth, I returned to my research, asking more people and was amazed by the number of close friends and family who were already on the CBD train. Apparently, I was the only one without a clue! And funny enough, a couple of friends who commented were using the same brand as my granddaughter—Zebra CBD. There was no consensus as to why they were using CBD, but the top reasons given were for muscle & joint discomfort, mood support, sleep support, stress and headaches, as well as supporting overall health & wellness.

Eventually, even the most skeptical of the bunch can be won over. With a trusted CBD source in mind, I decided to give it a go.

When I viewed Zebra CBD's selection online, I was impressed by its array of products, including CBD oils called tinctures, topicals, chewable tablets, mints and gummies. After reading on their website that all their products are made with organically-grown hemp, I ordered... and it arrived within 2 days!

The first product I tried was the Rub. Now this stuff was strong. Immediately after rubbing it on my knee, the soothing effects kicked in. It had that familiar menthol cooling effect, which I personally find very relieving. And the best part is, after two weeks of using it, my knee pain no longer affected my daily mobility.

The Zebra Sleep Gummies, on the other hand, had a different but equally positive effect on my body. To take it, the instructions suggest chewing thoroughly. This was simple enough, and the taste was, well, lemony. After about 15 minutes, a sense of calm came over my body. It's hard to describe exactly; it's definitely not a "high" feeling. It's more like an overall sense of relaxation—and then I fell fast asleep. Needless to say, I slept great and woke up refreshed. I haven't slept like that in a long time.

While it hasn't been a catch-all fix to every one of my health issues, it has eased the level and frequency of my aches. And it sure doesn't seem like a coincidence how rejuvenated I feel.

All-in-all, CBD is one of those things that you have to try for yourself. Although I was skeptical at first, I can safely say that I'm now a Zebra CBD fan and that I highly recommend their products.

Also, I managed to speak with a Zebra CBD spokesperson willing to provide an exclusive. If you order this month, you'll receive \$10 off your first order by using promo code "FH10" at checkout. Plus, the company offers a 100% No-Hassle, Money-Back Guarantee. You can try it yourself and order Zebra CBD at [ZebraCBD.com/FH](https://ZebraCBD.com/FH) or at 1-888-762-2699.

# MODERN WATER FOUNTAIN

////  
A SPLASH OF PEACE FOR YOUR PATIO



BY MIKE BERNER

**W**hen I think of deep relaxation, the sound of water immediately comes to mind: crashing ocean waves, the trickle of a nearby brook, a cascading waterfall, light rain—you get the idea.

To bring this calming sound to your backyard, I've designed a sleek water feature using a simple box for a reservoir, a pump and basic plumbing parts to keep the water flowing. It can be disassembled easily and tucked away for winter or moved around your patio. I dressed mine up by using ipe hardwood and wrapping the reservoir with a sheet of copper. Using the ideas I share here, you can build a modified version to fit your favorite relaxation spot.

## WHAT IT TAKES

TIME	COST	SKILL LEVEL
2 days	\$400	Intermediate

### TOOLS

Table saw, circular saw, miter saw, jigsaw, 18-gauge nail gun, basic woodworking tools



**SCAN THIS CODE TO WATCH THE BUILD AND HEAR THE CALMING SOUND OF FALLING WATER.**

## MEET THE BUILDER



**MIKE BERNER**, SENIOR PROJECT EDITOR, ENJOYS CREATING PROJECTS FOR EVERY LEVEL OF DIYER.

### 1 FRAME THE RESERVOIR

Cut the reservoir frame sides (A) and ends (B) from 2x2 lumber and fasten the bottom piece of marine plywood (C) to form the base of the reservoir.

Align the reservoir sides (D) with the ends of the base and fasten them to the 2x2s. Fasten the reservoir ends (E) to the 2x2s at the bottom with construction screws. Drive trim screws into the edges of the plywood toward the top.



### 2 PLACE THE LINER

Two options are available for lining the reservoir. Flat pond liners, available at home centers, are an inexpensive option but require a bit of origami to fit properly.

I ordered a custom heavy-duty box welded liner from everything-ponds.com that fit the reservoir perfectly. At \$200, it was more expensive, but it was well made, strong and easier to install.





### 3 FASTEN THE LINER

Rip the termination bar (F) down to 1/4-in., then cut it to fit inside the reservoir. Drill countersunk pilot holes every several inches, then clamp the termination bar and liner to the top of the reservoir and fasten them with 1-in. screws. This prevents the liner from sliding down.

### 3 IPE DECKING

I constructed the water curtain arm from ipe decking. It's a rot-resistant species that will do well outside for years with little maintenance.



### 4 LAYER THE WATER CURTAIN ARM

At the table saw, rip off the rounded edges of the ipe decking, leaving the boards about 5 in. wide. Then cut the horizontal (G) and vertical (H) outer arm parts to length with 15-degree angles on the ends. I cut each pair at the same time to ensure they were the same length and angle. Rip another piece of decking in half for the spine of the arm, and cut two pieces for each of the horizontal (J) and vertical (K) spine parts with the same 15-degree angles. Lay the parts on a flat surface; glue the pieces together, overlapping the spine.

### 5 FASTEN PLUMBING CLIPS

Before gluing and nailing the final layer of the arm assembly, fasten plumbing clips to hold the CPVC and vinyl tubing along the inside of the spine. Then fasten the final pieces of ipe to complete the arm.



# zzzzzzzz

## COMFORTABLY

with up to  
12 hours  
of overnight  
protection



Depend Night Defense  
has lightweight protection  
that absorbs all night, so  
you can sleep comfortably.



THE ONLY THING STRONGER THAN US, IS YOU.™

**FIGURE A**  
**WATER FOUNTAIN**

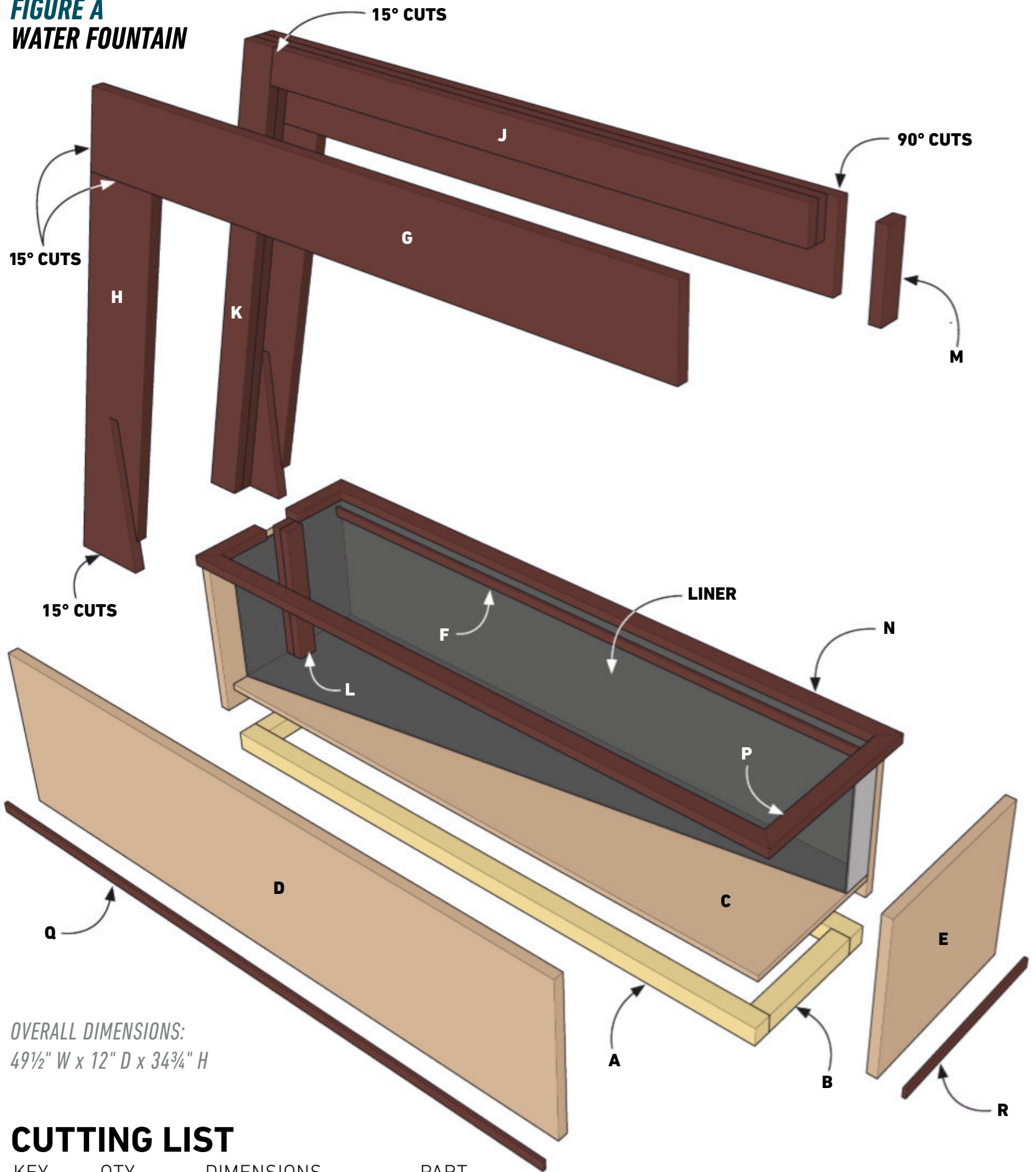

OVERALL DIMENSIONS:  
49½" W x 12" D x 34¾" H

## CUTTING LIST

KEY	QTY.	DIMENSIONS	PART
A	2	2x2 x 48"	Reservoir frame side
B	2	2x2 x 9"	Reservoir frame end
C	1	¾" x 12" x 48"	Reservoir bottom
D	2	¾" x 12½" x 48"	Reservoir side
E	2	¾" x 12½" x 13½"	Reservoir end
F	2	¼" x ¾" x 47½"	Termination bar
G	2	¾" x 5" x 44⅞"	Horizontal outer arm
H	2	¾" x 5" x 30⅞"	Vertical outer arm
J	2	¾" x 2½" x 40⅞"	Horizontal spine
K	2	¾" x 2½" x 3'	Vertical spine
L	2	¾" x 2½" x 9"	Arm support block
M	1	¾" x 1½" x 5"	Fountain arm cap
N	2	¾" x 2" x 50"	Top side trim
P	2	¾" x 2" x 14⅜"	Top end trim
Q	2	¾" x ¼" x 49½"	Lower side trim
R	2	¾" x ¼" x 14"	Lower end trim

## MATERIALS LIST

ITEM	QTY.
2x2 x 8'	3
¾" x 4' x 8' marine-grade plywood	1
2" construction screws	1 lb.
Pond liner	
12" copper coil	12'
¾" x 5½" x 8' ipe (or other rot-resistant or treated hardwood)	4
¾" CPVC pipe	4'
1" vinyl tubing	4'
Fountain pump	
Plumbing fittings	

## 6 NOTCH THE ARM

Using a Speed square indexed against the bottom of the arm, lay out a 12-in. tall by  $\frac{7}{8}$ -in. wide vertical notch to fit over the end of the reservoir. Transfer the mark to both sides of the arm and cut the notch using a circular saw and jigsaw.



## 7 WRAP THE RESERVOIR

I decided to wrap the plywood with copper rather than stain or paint it. To apply the copper, roll contact cement on the outside of the reservoir and onto the copper coil. Then carefully place the reservoir onto the copper. Apply one side at a time, folding the copper around the corners with a wood block. I planned for the seam of the copper to be hidden later by the water curtain arm. Once the copper is applied, press it firmly in place with a J-roller.



## 8 ATTACH THE ARM

Glue two ipe offcuts together to make the arm support block (L). Position this block on the inside of the reservoir to keep the arm in place. Fasten the block using screws from the outside, and seal it with silicone. Slide the arm over the reservoir edge and fit the plumbing channel over the block.





## 9 MARK A LINE

The CPVC pipe that makes the water curtain needs many holes drilled in a straight line. To get them all to line up, scribe a line across the pipe by clamping it down and dragging a marker flat along your work surface.

## 10 DRILL THE HOLES

Mark the hole locations along the line 1 in. apart. Fasten a pair of plumbing clips to a board to hold the pipe in place while you drill the holes, then clamp the board to the table to keep it in position. Slide the pipe through the clips and drill all the holes.



## 11 CONNECT THE FITTINGS

I spent a while in the plumbing department at my local home center piecing together the fittings needed to plumb the water curtain to the pump. I ended up using a 3/4-in. PVC end cap, a 3/4-in. push-to-connect x FIP brass adapter and a 3/4-in. MIP x barb brass adapter. After fitting these parts together, I pushed a length of 1-in.-dia. vinyl tube over the barb fitting and used a hose clamp to hold it in place.

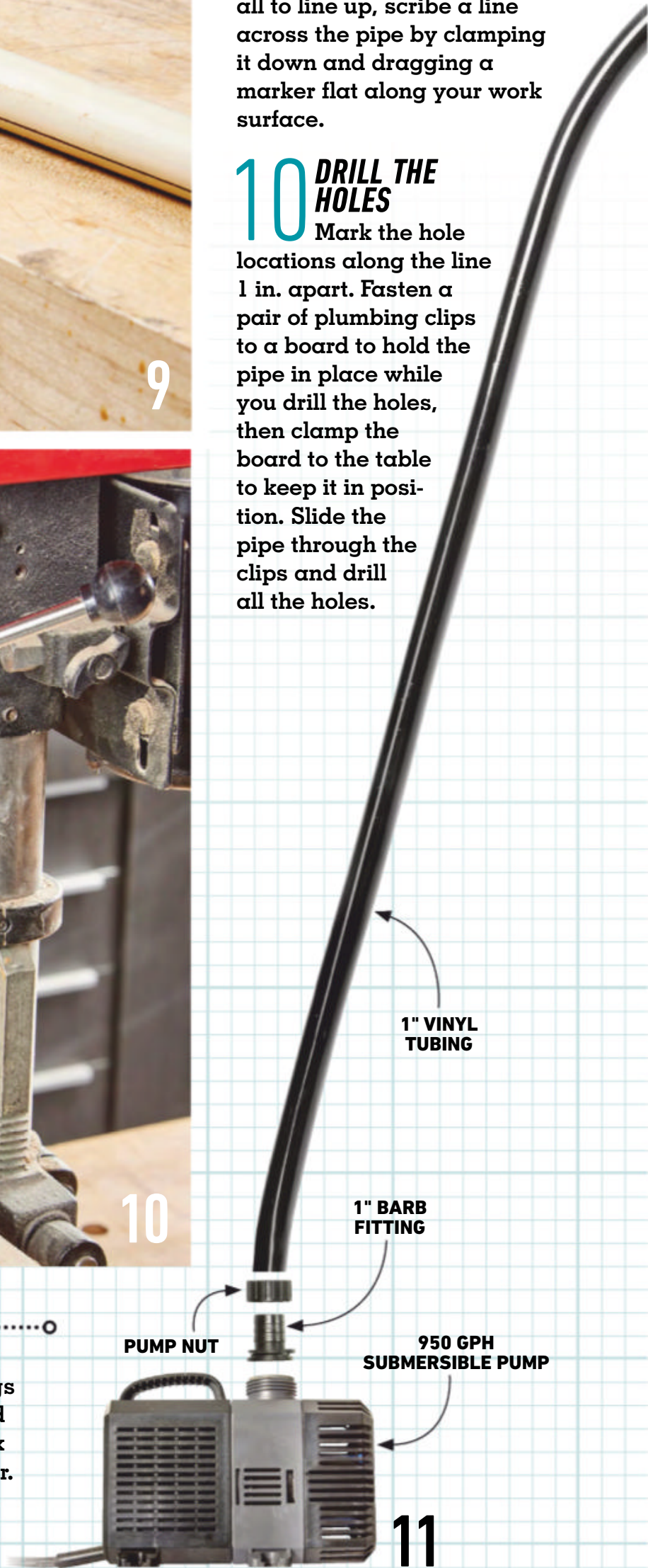



## 12 CONNECT THE PUMP

Snap the water curtain pipe into the plumbing clips, then cut the vinyl tubing long enough to connect to the pump. Slip the tubing onto a barb fitting on the pump and tighten the nut that connects the tubing to the pump. With the plumbing in place, I used an offcut of ipe to make the fountain arm cap (M).

## 13 TRIM THE BOTTOM AND TOP

Measure and cut miters on 2-in. wide pieces of ipe to make the top side (N) and end (P) trim pieces and fasten them with a bead of silicone and brad nails. Rip 1/4-in. ipe strips for the lower side (Q) and end (R) trim and fasten them around the bottom of the reservoir to cover the edge of the copper coil. 



## WHAT IT TAKES

**TIME**

2 days

**COST**

\$1,200

**SKILL LEVEL**

Beginner

**TOOLS**

Table saw, circular saw, jigsaw, cordless drill, basic carpentry tools



## MEET THE BUILDER



PROJECT EDITOR **JAY CORK** MISSES HAVING A HOBBY FARM, BUT THIS VERTICAL GARDEN PROVIDES HIM WITH PLENTY OF VEGGIES—WITHOUT ALL THE COYOTES.

# BUILD A VERTICAL GARDEN

TIME TO GROW UP!

BY JAY CORK

I love having a vegetable garden, but since I moved to the city, my space is limited. This vertical garden—a simple, attractive design built with cedar boards—has a small footprint and vertical “acreage” that makes the most of my urban backyard. And I appreciate that I can garden with a lot less bending!

## CHOOSING WOOD

Although pressure-treated lumber no longer contains arsenic, I still avoid using treated lumber where I’m growing food. Decay-resistant woods such as redwood and red cedar are two alternatives that look great and last for years.



### 1 MAKE THE FIRST LEG

Following Figure A, mark the cutting lines on a 2x6 cedar leg blank. Cut the stair steps and angled ends using any method you are comfortable with. I used a jigsaw and a miter saw.

**FIGURE A LEG DIAGRAM**

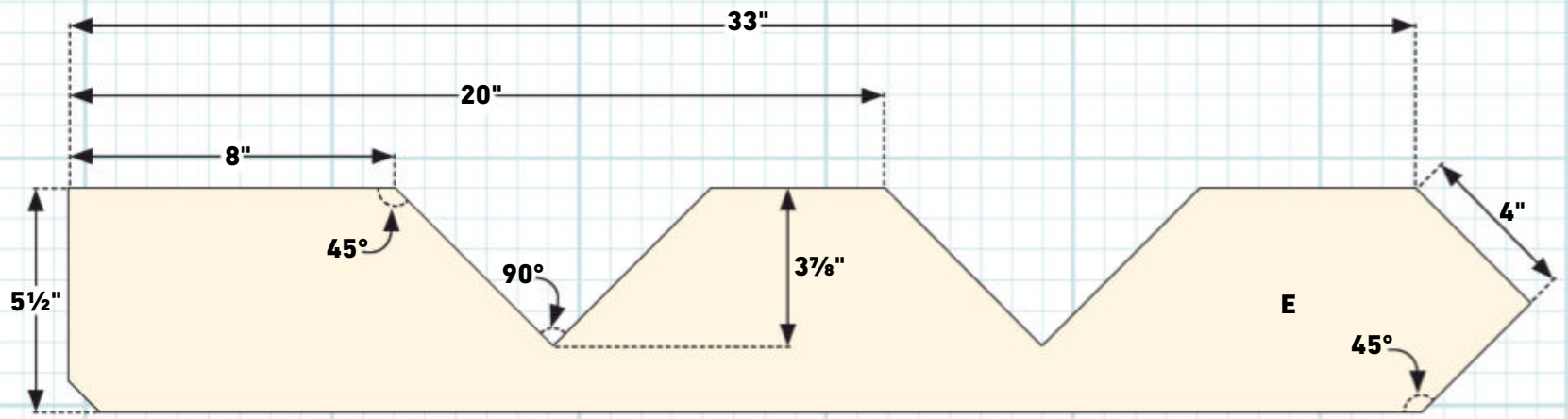

**FIGURE B SAW GUIDE**

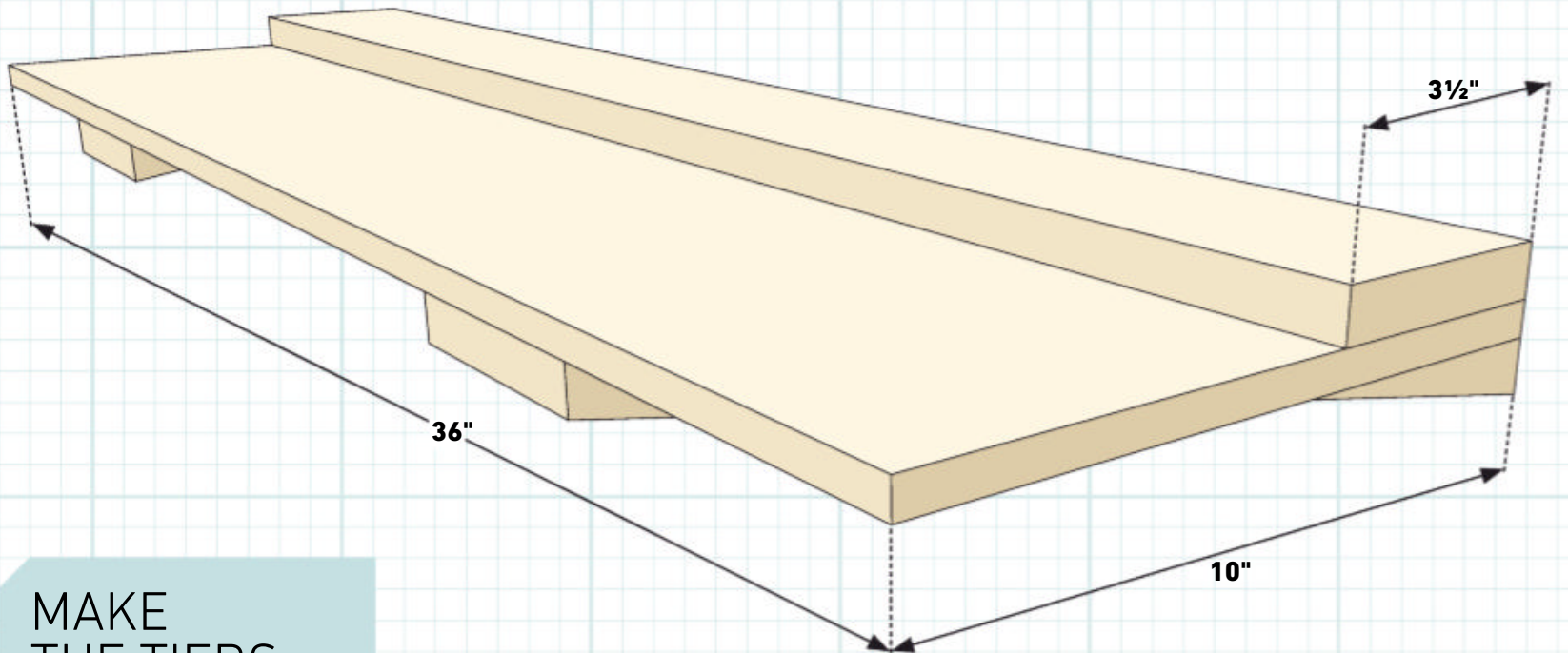

## MAKE THE TIERS

My favorite aspect of this project is its simplicity—it assembles with butt joints and requires only one setup on the saw. I designed this guide (Figure B) so that any circular saw can be used to make these compound miter cuts.

**FIGURE C SAW GUIDE BOTTOM**

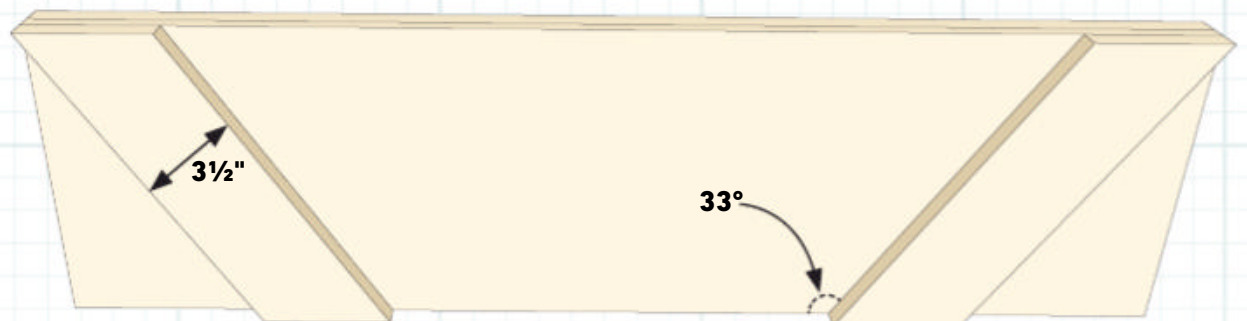

## CUTTING LIST

KEY	QTY.	DIMENSIONS	PART
A	3	62½" x 11¼" x 1½"	Tier 1 sides
B	3	48½" x 11¼" x 1½"	Tier 2 sides
C	3	34½" x 11¼" x 1½"	Tier 3 sides
D	3	20½" x 11¼" x 1½"	Tier 4 sides
E	3	33" x 5½" x 1½"	Stand legs
F	1	36" x 1½"	Dowel

## MATERIALS LIST

ITEM	QTY.
2x12 x 8' cedar boards	12
2x6 x 8' cedar boards	3
1½" dowel	1
2½" trim screws	Box

## 2 CUT THE REMAINING LEGS

Use the first leg as a template to lay out the other two. Cut them as you did the first one.

## 3 ASSEMBLE THE TRIPOD

Make a mark every 1½ in. around the circumference of the center support dowel to indicate the spacing for the legs. Drill pilot holes through the dowel and use 2½-in. screws to attach the legs.

## 4 CUT THE TIER SIDES

Clamp the saw guide to the 2x12 cedar and make one angled cut across the cedar board. Make the mark for the opposing cut from the top corner, and then flip the guide around and make the second cut. Make three sides for each tier level.

### SET UP THE SAW GUIDE

Tilt the blade on the saw to 16 degrees and make a cut on the saw guide. This will make the zero-clearance base for your saw. Now you can line up all your cuts to the cut edge at the bottom of the guide.





## FIGURE D TIER PARTS

OVERALL DIMENSIONS:  
64 1/2" W x 36" H x 64 1/2" D

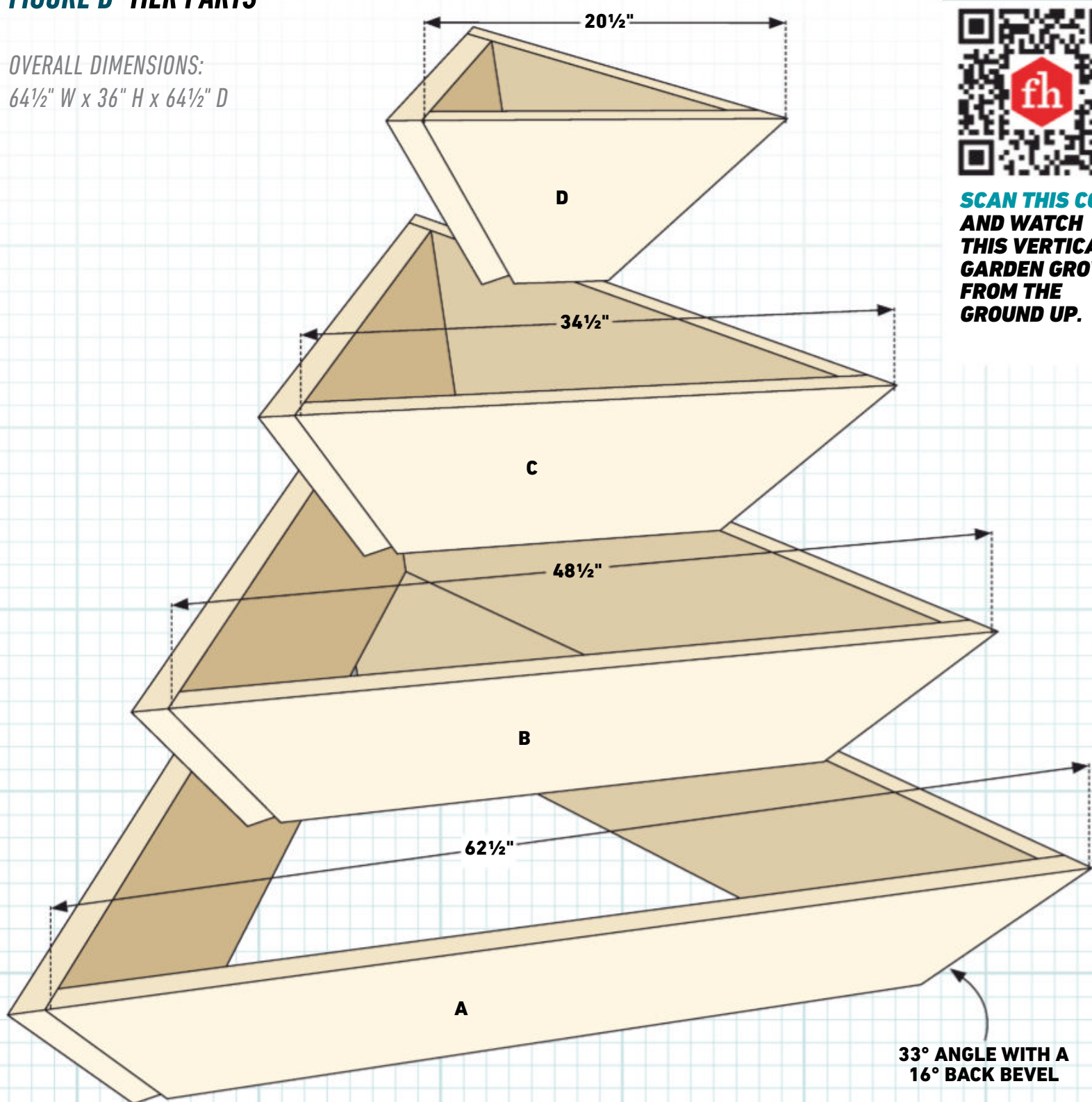

SCAN THIS CODE  
AND WATCH  
THIS VERTICAL  
GARDEN GROW  
FROM THE  
GROUND UP.



## 5 BEVEL THE TOP EDGES

Before assembly, bevel the top edges of the boards so they appear level when assembled. With the table saw blade set to 22½ degrees, trim the top (long) edge with the short edge against the fence.

## 6 ASSEMBLE THE TIERS

With one side flat on the workbench, tack the next side in place with brad nails, then secure it with trim screws. Finish with the third side.

## 7 FIND LEVEL GROUND

Find or create a level area where the lower tier and legs can sit. It doesn't have to be perfectly level; just make sure it's not tilting too much. Set the lower tier with the leg stand centered inside. Set the second tier and start filling with soil.

## 8 PLANT AND ENJOY

Fill the garden with soil as you stack the tiers. Now you're ready to start growing! This vertical garden is perfect for herbs and small greens. Even carrots would do well! And be sure to check out "Grow Mini Vegetables" on p. 30. 



**Grizzly**  
Industrial®  
Quality Machines, Great Prices!

### 6¼" TRACK SAW BUNDLE



\$28  
SHIPPING

⚠️ WARNING! †  
T33300X ONLY \$185

### 8" COMBO PLANER/JOINTER WITH SPIRAL CUTTERHEAD



\$28  
SHIPPING

⚠️ WARNING! †  
G0958 ONLY \$549

### 8" BENCHTOP DRILL PRESS



⚠️ WARNING! †  
G0925 ONLY \$119

### 12½" 2 HP BENCHTOP PLANER



\$59  
SHIPPING

⚠️ WARNING! †  
G0505 ONLY \$395

### 10" DOUBLE-BEVEL SLIDING COMPOUND MITER SAW



\$79  
SHIPPING

⚠️ WARNING! †  
T31634 ONLY \$425

### THE CLASSIC 14" BANDSAW



\$199  
SHIPPING

⚠️ WARNING! †  
G0555 ONLY \$749

### 10" 2 HP BENCHTOP TABLE SAW



\$59  
SHIPPING

⚠️ WARNING! †  
G0869 ONLY \$495

### 3-SPEED HEPA HANGING AIR FILTER



⚠️ WARNING! †  
T33150 ONLY \$495

Financing Available



**grizzly.com.**

**800-523-4777**

Due to rapidly changing market conditions, our advertised prices may be changed at any time without prior notice. Please visit [grizzly.com](http://grizzly.com) for up-to-date pricing.

⚠️ WARNING! † : Cancer & Reproductive Harm

Some products we sell can expose you to chemicals known to the State of California to cause cancer and/or birth defects or other reproductive harm. For more information go to [www.P65Warnings.ca.gov](http://www.P65Warnings.ca.gov)

# GROW MINI VEGETABLES

////  
GROW A GARDEN  
IN A TINY SPACE!



POT-A-PENO  
PEPPER

**I**n the late 1980s, I carved out space for my first vegetable garden from a 1-ft. wide strip of soil between my apartment patio and a fence. I did my best to squeeze some green beans and a few tomato plants into that little space. Today, with that same limited space, I can grow dozens of mini vegetable varieties.

BY CAROL J. MICHEL

PHOTO: ALL-AMERICA SELECTIONS/POT-A-PENO

## WHAT ARE MINI VEGETABLES?

Mini vegetables, also referred to as dwarf or compact vegetables, are vegetable plants that are much smaller than their standard counterparts. According to Josh Kirschenbaum, PanAmerican Seed vegetable accounts manager, no parameters are set for what defines a dwarf vegetable, but they are notably smaller than a standard-size vegetable and can perform well in a container.

Like full-size vegetable plants, dwarf or mini vegetable plants usually require full sun. When they're grown in containers, you'll also need to water them more frequently—as often as once or twice a day during the hottest days of summer, depending on the size of the container. You'll also need to fertilize them more often because frequent watering quickly leaches out the nutrients the vegetables need to thrive.

## A LITTLE HISTORY

As Jen McGuinness noted in her book *Micro Food Gardening: Project Plans and Plants for Growing Fruits and Veggies in Tiny Spaces*, people are moving to cities, and by 2050, well over half of us will live in an urban environment. Fortunately, the plant industry recognizes this, and plant breeders at companies such as PanAmerican Seed started breeding dwarf vegetable varieties about 15 years ago with a focus on those that grow well in both containers and hydroponic systems, such as the AeroGarden.

## WHY GROW MINIS?

You won't harvest bushels of produce when you grow mini vegetables or fruits, but there are still many good reasons to grow them.

### ENJOY HOMEGROWN TASTE.

You'll discover that homegrown vegetables, even small ones, often taste better than varieties you buy in grocery stores. Plus, you can't get fresher vegetables than those you pick and eat right away. If you grow dwarf

vegetables using an indoor hydroponic system, you can also get that fresh taste year-round.

### SPEND LESS TIME AND EFFORT.

Planting mini vegetables in containers takes less time and overall effort than planting a vegetable garden in the ground.

**TEACH KIDS ABOUT FOOD.** When kids see dwarf vegetables growing up close, they learn where their vegetables come from.

### GAIN EXPERIENCE TO GROW

**FULL-SIZE VEGETABLES.** Many people are timid about planting a large vegetable garden, even when they have the space for it. After having success with dwarf vegetables, you may have the desire to grow regular-size vegetable plants.

## THE CHALLENGES

Growing dwarf vegetables isn't completely trouble-free. They can still be attacked by the same insect pests and diseases found in in-ground vegetable gardens.

You'll also need to spend time caring for them. This often means daily watering and weekly fertilizing with plant fertilizer labeled for use with vegetables. Lastly, the containers, potting soil or hydroponic system can cost quite a bit initially. Fortunately, most containers can be reused for years.



KATARINA CABBAGE

## TABLETOP VEGETABLES

If your only growing space is a sunny windowsill or a small table outdoors, "tabletop vegetables" may be your best option. Kitchen Minis from PanAmerican Seed were bred to be grown in small containers. You buy the potted vegetable plant and enjoy picking fresh vegetables for a few weeks.

Once they've stopped producing, you can compost the plants and recycle the containers. Several varieties of sweet peppers, hot peppers and cherry tomatoes are available now. A cucumber called Quick Snack is in the works. Find out more at [kitchenminis.com](http://kitchenminis.com).

## CHOOSING YOUR VEGETABLES

*Deciding which mini vegetables to grow is the same as deciding which vegetables to grow in a regular garden.*

- Choose vegetables you already love to eat. Maybe try one or two you don't like and see if you like the homegrown version.
- How big will the plant get at maturity? *Dwarf*, *mini*, *compact* and *ultra-compact* are all terms used to describe smaller vegetable plants. Read the label to determine the mature size so you won't be surprised.
- How big will the vegetables you harvest be? Some dwarf plants also produce much smaller vegetables, while others grow vegetables that are almost full size.
- Don't limit yourself to just vegetable plants labeled as dwarf, compact, mini, etc. Also look for full-size varieties—which may be naturally smaller plants to begin with—that are described as growing well in containers.
- Finally, choose a few varieties that you can eat as you pick them. Nothing is better than a fresh, sun-warmed cherry tomato right off the vine.

# HERE ARE 12 OF OUR FAVORITES

## 1 GREEN BEAN: MASCOTTE

This is another vegetable that tastes its best when freshly picked. If you don't have room for a big row of beans, try Mascotte (burpee.com), a dwarf plant that produces beans up to 5 in. long. It was named an All-America Selections winner in 2014.

If you keep picking the beans as they mature, which takes about 50 days from sowing, the plants should keep flowering and produce more beans for several weeks.

- Sow seeds directly in containers when the possibility of frost has passed, spacing the seeds according to the instructions on the packet.
- Seeds should germinate in a few days.

## 2 CABBAGE: KATARINA

It's surprising how big a cabbage plant can get and how much better homegrown cabbage tastes. Try Katarina (territorialseed.com), which produces a small, tasty head of cabbage and grows well in larger containers. This cabbage tolerates light frosts so you can get an early start by putting it outside a few weeks before your last frost.

You should have mature cabbage heads ready to harvest in about six weeks. This cabbage variety was named an All-America Selections winner in 2016.

- Sow seeds indoors four to six weeks before transplanting outdoors or buy transplants in early spring.
- To keep cabbage butterfly larvae from eating the leaves, you may need to cover them with a light horticultural cloth.

## 3 CUCUMBER: PATIO SNACKER

Cucumber Patio Snacker (territorialseed.com) is a dwarf vegetable variety you can grow in a large container. Cucumber plants are vines, so add a small trellis to give the vines something to climb up.

The big surprise is that this plant, although smaller than most cucumber plants, produces larger cucumbers, up to 7 to 8 in. long, in 50 days or so.

Keep picking the cucumbers to encourage the vine to keep flowering. Also, encourage bees to visit your plant by planting flowers nearby. Cucumbers produce separate male and female flowers and need bees to pollinate them.

- Sow seeds directly outside in a large container.
- Thin to one or two seedlings by carefully pulling out the other seedlings.

## 5 TOMATO: LIZZANO

If you are looking for the classic cherry tomato to grow in a container on your patio, try Lizzano (territorialseed.com). It was an All-America Selections winner from 2011.

This variety produces fruit over a long period and is resistant to late blight. In a container on the ground, it will need a cage or other support, but it also does well in a large hanging basket where it can hang down from the edges.

- Start seeds indoors six to eight weeks before your first frost-free date or purchase plants in late spring.
- Harden off seedlings by placing them outside in shade for a few hours a day when temperatures are above 60.
- Plant seedlings in their permanent container once there is no risk of frost.

## 6 TOMATO: PATIO CHOICE YELLOW

Cherry tomatoes may be small, but that's not true of all cherry tomato plants. Patio Choice Yellow F1 (trueleafmarket.com) was an All-America Selections winner from 2017. It's a smaller plant that does well on a patio in a container.

To keep your tomatoes (and all mini vegetables in containers) healthy and growing, fertilize them regularly with a liquid

## 4 WATERMELON: CAL SWEET BUSH

You may think there is no way you can grow a watermelon in a container, but you can! Cal Sweet Bush is a compact bush-type plant with short vines that grows well in containers. An All-America Selections winner in 2019, it's available at trueleafmarket.com.

Let it grow all summer and in about 90 days, you'll have your own homegrown watermelon. Just remember to grow it in full sun and keep it watered throughout the summer.

- Sow seeds directly outside in a large container.
- Thin to one seedling, the strongest, by carefully pulling out the other seedlings.
- One seedling should produce one watermelon.





**PATIO CHOICE  
YELLOW  
TOMATO**

fertilizer because nutrients can quickly leach out of the soil with regular watering.

- Start seeds indoors six to eight weeks before your first frost-free date or purchase plants in late spring.
- Harden off seedlings by placing them outside in shade for a few hours a day when temperatures are above 60 degrees.
- Plant seedlings in their permanent container once there is no risk of frost.

## 7 PEPPER: QUICKFIRE

You can round out your mini vegetable collection of peppers with a hot Thai-type pepper called Quickfire (parkseed.com). An All-America Selections winner from 2022, it produces hot peppers on smaller plants, perfect for containers. The hot peppers show above the foliage, so they are easy to harvest when you need one to spice up a favorite dish.

Some gardeners wonder if hot peppers grown next to sweet peppers make the sweet peppers hot too. They don't. Growing them near each other won't affect the taste of either one.

- Start seeds indoors six to eight weeks before your first frost-free date or purchase plants in late spring.
- Harden off seedlings by placing them outside in shade for a few hours a day when temperatures are above 60.
- Plant seedlings in their permanent container once there is no risk of frost.



## 8 TOMATO: LITTLE NAPOLI

Not all dwarf tomato plants produce cherry tomatoes. Little Napoli (from burpee.com) is a mini plant that produces a Roma-type tomato, the type used to make tomato paste and sauce.

Little Napoli grows best in a large container with some support in the form of a small tomato cage or sturdy stakes. Tie the vines loosely to the stakes or gently guide them to grow up through the cage. This helps the plant grow upright, which ensures good fruiting. It needs full sun, and in a container may need daily watering.

- Start seeds indoors six to eight weeks before your frost-free date or purchase plants in late spring.
- Harden off seedlings by placing them outside in shade for a few hours a day when temperatures are above 60.
- Plant seedlings in their permanent container once there is no risk of frost.

## 9 EGGPLANT: PATIO BABY

Even if you don't like eggplant, grow this dwarf variety, Patio Baby (burpee.com) and try cooking the small eggplants it produces. Because the plants top out at less than 2 ft. tall, they do well in large containers in full sun.

A unique feature of this eggplant variety, an All-America Selections winner in 2014, is that it doesn't have thorns on the leaves or calyxes (that green cap where the eggplant attaches to the plant itself), like other eggplants. This is a big plus at harvest time.

- Start seeds indoors six to eight weeks before your frost-free date or purchase plants in late spring.
- Harden off seedlings by placing them outside in shade for a few hours a day when temperatures are above 60.
- Plant seedlings in their permanent container once there is no risk of frost.



## 10 PEPPER: JUST SWEET

When it comes to mini peppers, there are many varieties to choose from, including Just Sweet (parkseed.com). An All-America Selections winner in 2019, these pepper plants can grow up to 3 ft. tall, but don't need to be staked.

The peppers are sweet and good for snacking. When mature, they turn yellowish orange. Keep picking the peppers and the plant should keep flowering and producing more throughout the growing season.

- Start seeds indoors six to eight weeks before your first frost-free date or purchase plants in late spring.
- Harden off seedlings by placing them outside in shade for a few hours a day when temperatures are above 60.
- Plant seedlings in their permanent container once there is no risk of frost.

## 11 BASIL: EMERALD TOWERS

Emerald Towers from burpee.com is a tall basil plant that grows almost straight up, making it a good accent plant in a container with other edible plants. Plus, it's slow to produce flowers, which allows you to harvest leaves from it for most of the growing season. These plants don't need a large container to grow in but should be watered regularly.

- Start seeds indoors four to five weeks before your first frost-free date or purchase plants in late spring.
- Harden off seedlings by placing them outside in shade for a few hours a day when temperatures are above 60.
- Plant seedlings in their permanent container once there is no risk of frost. You can also direct sow seeds in containers outdoors after your garden is frost-free.



## LOVE FRESH PEAS?

You can grow Peas-in-a-Pot on your patio too. Bred for containers and small space gardens, it's a 10-in. plant with a good yield. Check it out at burpee.com.

## 12 PEPPER: POT-A-PENO

Pot-a-Peno was an All-America Selections winner in 2021. This jalapeno-type pepper from burpee.com grows well in a container or a hanging basket where it will cascade down the sides.

You can pick the peppers while green or let them ripen to red. Not only will the color change, but the flavor will too. Try them both ways!

- Start seeds indoors six to eight weeks before your first frost-free date or purchase plants in late spring.
- Harden off seedlings by placing them outside in shade for a few hours a day when temperatures are above 60.
- Plant seedlings in their permanent container once the risk of frost has passed. 

### MEET THE EXPERT



**CAROL J. MICHEL**, AN AWARD-WINNING AUTHOR, ALSO HAS A BLOG CALLED *MAY DREAMS GARDENS*.



Watering chores, water bills! Sweating behind a roaring mower! Spraying poison chemicals and digging weeds...



...you can end such lawn drudgery – here's how!



## THE ONE-TIME, LIFETIME LAWN SOLUTION

Stays lush and green in summer

Mow your Zoysia lawn once a month – or less! It rewards you with weed-free beauty all summer long.

# 7 Ways Our Amazoy™ Zoysia Lawn Saves You Time, Work and Money!

## 1 CUTS WATER BILLS AND MOWING BY AS MUCH AS 2/3

Would you believe a lawn could look perfect when watered just once? In Iowa, the state's biggest Men's Garden club picked a Zoysia lawn as "top lawn—nearly perfect." Yet, this lawn had been watered only once all summer!

## 2 NO NEED TO DIG UP OLD GRASS

Plant Amazoy in an old lawn or bare ground. Set plugs into holes in the soil checkerboard style. Plugs spread to create a lush, thick lawn, driving out weeds. Easy instructions included with every order.

## 3 ENVIRONMENTALLY FRIENDLY

No weeding means no costly chemicals. Amazoy Zoysia lawns naturally resist insects, so you'll save money, while helping to protect the environment. Never expose your family and pets to weed killers and pesticide poison.

## 4 FOR SLOPES, PLAY AREAS, BARE SPOTS AND PARTIAL SHADE

Can't beat Amazoy as the low-cost answer for hard-to-cover spots, play-worn areas, partial shade and erosion on slopes.

## 5 IT STAYS GREEN IN SPITE OF HEAT AND DROUGHT

"The hotter it gets, the better it grows!" Amazoy Zoysia thrives in blistering heat, yet it won't winter-kill to 30° below zero. It goes off its green color after hard frosts, and begins regaining its green color as temperatures in the spring are consistently warm.



Thrives from partial shade to full sun.



Plant it from plugs.

## 6 CHOKES OUT CRABGRASS AND WEEDS ALL SUMMER

Your established Zoysia lawn grows so thick, it simply stops crabgrass and most summer weeds from germinating!

## 7 NOW 3 WAYS TO START YOUR AMAZOY ZOYSIA LAWN!

**1) Freestyle Plugs** come in uncut sheets containing a maximum of 150–1" plugs that can be planted up to 1 ft. apart. Freestyle plugs allow you to make each plug bigger and plant further apart – less cutting and planting – you decide.

**2) New Super Plugs** come pre-cut into individual 3"x3" plugs ready-to-plant (minimum 1 per 4 sq. ft.). They arrive in easy to handle trays of 15 Super Plugs. Save time and get your new lawn faster!

**3) Amazoy Approved Seed** – As The Zoysia Specialists for 70 years, we now have a Zoysia seed that meets our standards and homeowners expectations.

### Your Assurance of Lawn SUCCESS Amazoy Zoysia Grass is GUARANTEED

Guaranteed to grow new green shoots within 45-60 days or we'll replace it **FREE** – for up to 1 year – just call us. Valid on one order at a time, typically the most recent. We **ONLY** ship you mature, hardy field grown genuine Amazoy Zoysia grass harvested direct from our farms. Easy planting and watering instructions are included with each order.

© 2023 Zoysia Farm Nurseries, 3617 Old Taneytown Rd, Taneytown, MD 21787

**ORDER TODAY – GET UP TO 1,500 FREESTYLE PLUGS – FREE!**

Meyer Zoysia Grass was perfected by the U.S. Gov't, released in cooperation with the U.S. Golf Association as a superior grass.

**Freestyle Plugs** You decide how big to cut the plugs. Each grass sheet can produce up to 150-1 in. plugs. Plant minimum 1 plug per sq. ft.

Max Plugs	Free Plugs	Grass Sheets	Your PRICE	+Shipping	SAVINGS
450	—	3	\$ 47.50	\$22.00	—
750	+150	6	\$ 72.50	\$27.50	25%
1100	+400	10	\$110.00	\$40.00	32%
2000	+1000	20	\$180.00	\$65.00	46%
3000	+1500	30	\$240.00	\$75.00	52%

**Super Plugs** Precut plugs 3 inches by 3 inches READY TO PLANT Packed in trays of 15 Super Plugs. Plant minimum 1 plug per 4 sq. ft.

Super Plugs	Free Plugs	Tray	Your PRICE	+Shipping	SAVINGS
15	—	1	\$ 27.50	\$15.00	—
25	+5	2	\$ 42.50	\$20.00	25%
60	+15	5	\$ 97.50	\$32.00	35%
120	+30	10	\$145.00	\$50.00	53%
240	+60	20	\$260.00	\$90.00	59%

### EVERYTHING YOU NEED TO START AND MAINTAIN A CAREFREE BEAUTIFUL ZOYSIA LAWN

Scan QR code to learn more



PLANTING TOOLS • PLANT FOOD • WEED AND PEST CONTROLS  
ORGANIC PRODUCTS • SOIL TESTS • GARDEN GLOVES • EDGING and more!

[www.ZoysiaFarms.com/mag](http://www.ZoysiaFarms.com/mag) OR 410-756-2311

Harvested Daily from Our Farms and Shipped to You the Same Day the Plugs are Packed

Amazoy is the Trademark Registered U.S. Patent Office for our Meyer Zoysia grass.

Savings shown over aggregate base price and shipping

**Zoysia Farm**  
NURSERIES

Improving America's Lawns Since 1953

Use Promo Code **5043**

# DIY HYDROPONIC GARDEN

////  
FRESH VEGETABLES  
AT YOUR FINGERTIPS

used to think hydroponic gardening was a complex science that was out of my reach. But it's just PVC parts, a pump and some water. Building a hydroponic garden is faster and easier than preparing a soil garden

BY KARUNA EBERL

bed. Plus, it produces faster-growing vegetables with a fraction of the water. We made a system compact enough to sit on a table in a small house or apartment, but still large enough for nightly salads. It can even be moved outdoors for the summer and inside for the winter.

PHOTOS: KARUNA EBERL AND STEVE ALBERTS

**FIGURE A**  
**HYDROPONIC GARDEN**

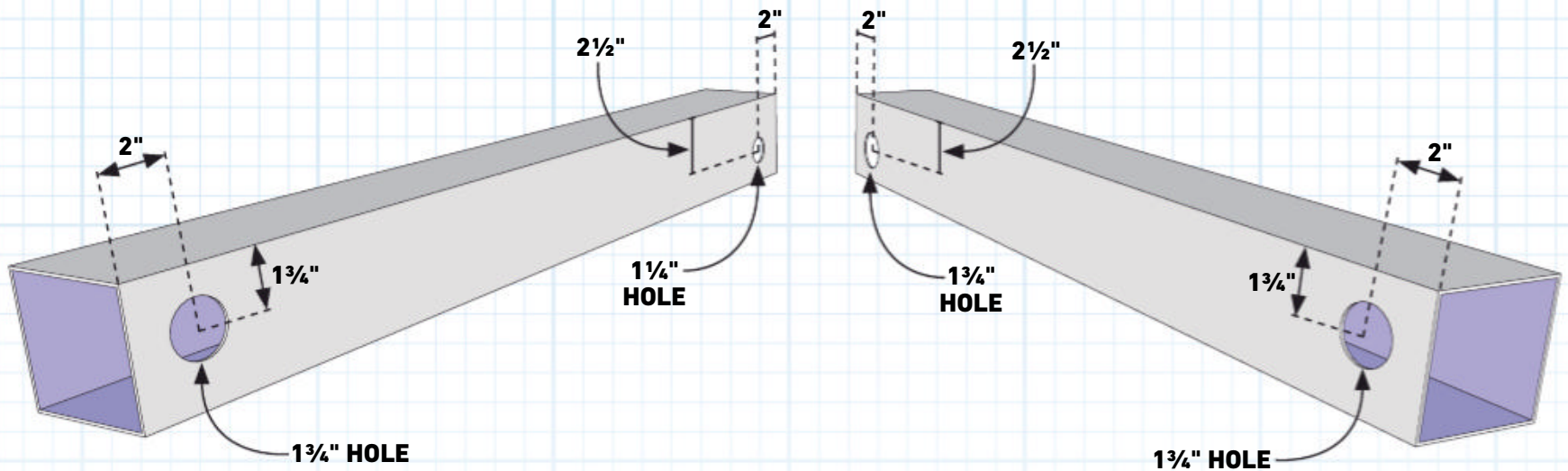

## MATERIALS LIST

ITEM	QTY.
1' length of 1" PVC Schedule 40 pipe	1
10-piece package of 3" net cups for hydroponics	1
10.2 oz. clear aquarium silicone sealant	1
27-gal. tough storage bin with lid (should not be translucent)	1
4 oz. Gorilla Clear PVC PrimaGlue	1
4" square PVC fence post, 6' long	1
50-piece package of black plastic slotted mesh net plant cups for hydroponics	1
Boshart 1" insert x 1" D MPT Polypropylene 90-degree elbow	1
Boshart 1/2" insert x 1/2" D MPT Polypropylene 90-degree elbow	1
Kedsum 660 gph submersible Ultra Quiet water pump with 6' lift height	1
Lifegard Aquatics 1/2" double-threaded bulkhead	1
Package of TotalPond vinyl tubing: 1/2" diameter	1
Package of plant nutrients	1
1" Schedule 40 PVC union	1
Sealproof 1" diameter corrugated pond tubing: 20' length	1
Sheet of 120-grit sandpaper	1
Sheet of 28 small plugs: 1.5" Rockwool starter plugs for hydroponics	1
Charlotte Pipe 1" Schedule 40 MPT x S male adapter	2
Lifegard Aquatics 1" double-threaded bulkheads	3
4" white vinyl pyramid-style fence post caps	4
90-degree elbow: 1" barbed x NPT male	1

**1 CUT YOUR FENCE POSTS**  
Cut the 6-ft. PVC fence post into two 36-in. pieces. Cut the ends as straight as possible so the end caps seal properly. Also cut two 2 1/2-in. pieces of 1-in. Schedule 40 pipe.

### MEET THE EXPERTS



**KARUNA EBERL AND STEVE ALBERTS** ARE ON THE FINAL STRETCH OF RENOVATING AN ABANDONED HOUSE IN A NEAR-GHOST TOWN IN RURAL COLORADO.

### WHAT IT TAKES

TIME	COST	SKILL LEVEL
1 day	\$300	Beginner

#### TOOLS

Hole saws: 1 1/4", 1 1/2", 1 3/4" and 2 1/2"; 3/4" paddle bit, handsaw, measuring tape, miter saw, permanent marker, drill/driver

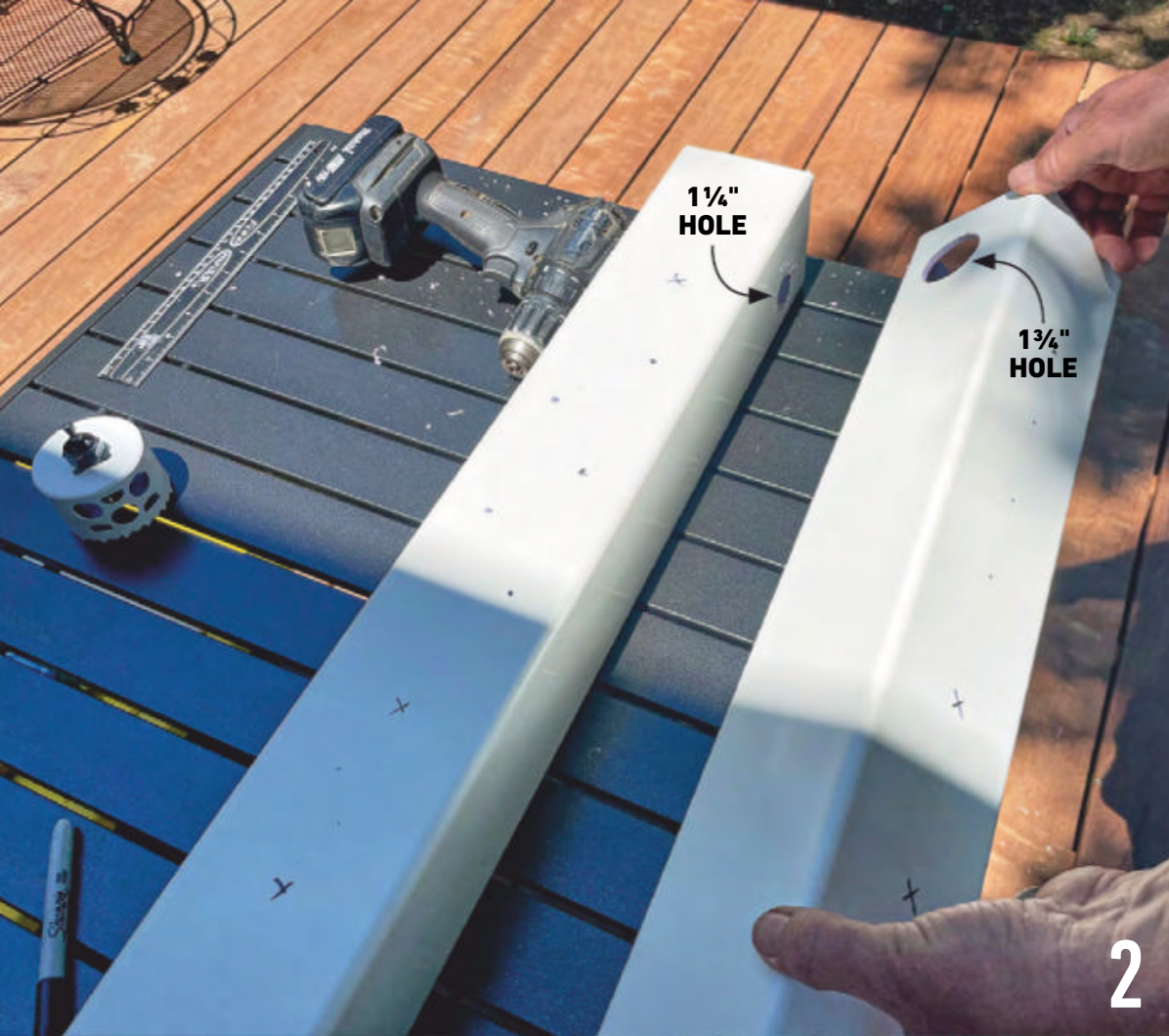

## 2 DRILL THE CONNECTION HOLES

Drill the connection holes in your 4-in. PVC fence post sections. Three of the holes are 1 $\frac{3}{4}$  in. diameter and one hole is 1 $\frac{1}{4}$  in. diameter. (See Figure A for hole locations.) These holes will face each other on the inside vertical faces and are used to connect the two rails.

## 3 LAY OUT THE CUP PATTERN

Use a permanent marker to indicate the center for each hole. Leave at least 3 in. of space at each end so you don't interfere with the fittings to be installed later.

## 4 DRILL THE CUP HOLES

Drill cup holes on the top faces of the rails. Drill 1 $\frac{1}{2}$ -in. holes for small cups and 2 $\frac{1}{2}$ -in. holes for large cups. After drilling the holes, use sandpaper to smooth the edges of the holes.

### PRO TIP

Small net cups are good for shorter-term plants like lettuce. Large net cups are good for longer-term plants such as peppers and strawberries.



## 5 GLUE THE RAIL CONNECTION FITTINGS

Assemble the fittings and 1-in. PVC lengths in the order shown in Photo 5B. Apply the PVC glue to the inside of the receiving fitting and the outside of the inserting fitting (Photo 5A). Push the pieces together while giving them a slight twist, about a quarter turn. Hold pressure for 30 to 45 seconds, or until the fittings don't pull apart.

## 6 INSERT THE BULKHEAD FITTINGS

Insert the fittings in the connection holes you drilled in Step 2. The threads go inside the square post, and the gasket seals go on the outside. Tighten the nuts onto the threads until the fittings are tight.



5A

5B



6



7A

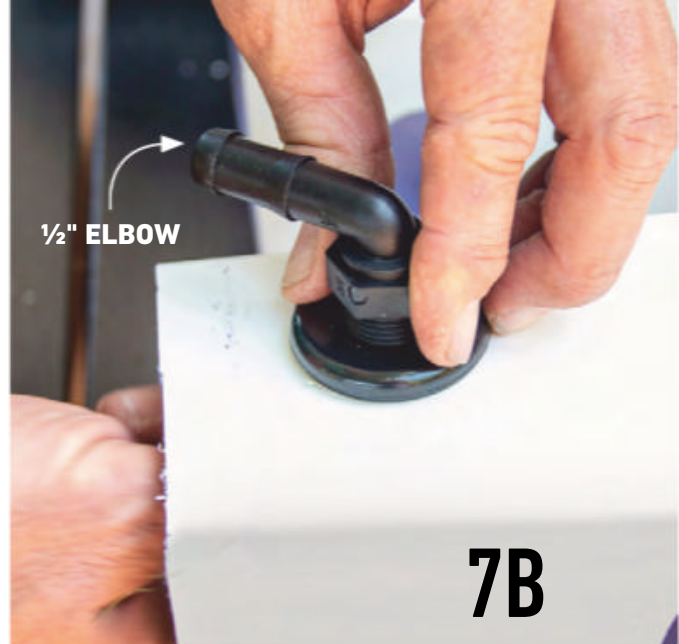

7B

## 7 ADD THE FITTINGS

Attach the PVC fittings on the matching post ends. Insert the 1/2-in. elbow into the 1/2-in. bulkhead fitting (Photo 7B). Insert the 1-in. elbow into the 1-in. bulkhead fitting directly across from 1/2-in. fitting. Angle elbows downward 45 degrees to connect to the water reservoir.

## 8 SEAL AND GLUE END CAPS

Apply silicone to the inside of each end cap, with a bit extra in the corners. Then apply PVC glue along the inside edge of the cap, adjacent to the silicone. Apply glue to the outside of the post. Push the end cap in place and hold for 30 to 45 seconds. Fill any gaps in the corners with silicone.



8



9



10A



10B

## 9 CONNECT THE RAILS

Place your rails next to each other with the union fittings aligning with the other halves. Tighten the union fittings as much as you can by hand.

## 10 PREPARE THE WATER RESERVOIR

Drill a 1 1/4-in. hole through the bin lid for the out-flow tubing. Drill a 3/4-in. hole through the side of the reservoir near the top of the sidewall for the inflow waterline that will connect to the water pump. Drill another 3/4-in. hole next to the inflow waterline for the cord to pass through. Place the water pump in the center of the reservoir and route the cord through the 3/4-in. hole next to the inflow tubing hole.



10C



**SCAN THIS CODE TO LEARN MORE ABOUT HYDROPONIC GARDENING.**

11



12



13

## 11 ATTACH INFLOW AND OUTFLOW TUBING

Push the corrugated tubing onto the 1-in. elbow barb. Route the 1-in. corrugated tubing through the top of the reservoir in the 1¼-in. hole. Leave about 8 in. in the reservoir and cut off the remaining length. Push the inflow ½-in. tubing onto the elbow barb, route it through the ¾-in. hole in the side next to the cord and cut it to appropriate length. Push the inflow tubing onto the pump barb until it's fully seated. Fill the water reservoir three-quarters full and add any necessary nutrients.

## 12 PREPARE NET CUPS

You can use seeds, seedlings or starter plants from a nursery. If your plants come in soil, remove as much of it as you can from the roots before inserting them in the Rockwool starter plugs.

## 13 FINISH IT UP

Plug in the pump and insert the plant cups into the holes in the rails. Don't leave any holes empty. Open holes let sunlight into the system, which promotes algae growth. 

**COMMERCIAL GRADE. ALL DAY POWER.**



Commercial Grade



All Day Power



User Friendly



Planet Friendly



Find a Dealer at: [meangreenproducts.com](http://meangreenproducts.com)

# EARTH-FRIENDLY WEED KILLERS

HEALTHIER CHOICES  
FOR HUMANS AND  
THE ENVIRONMENT

BY ETHAN O'DONNELL

**U**nless you have been living under a rock, you are bound

to have come across one of the many reports outlining the toxic chemicals that are used in herbicides and their long-term effects on both human beings and the environment. As a result, environmentally friendly products with active ingredients such as vinegar, salt, soap and essential oils have gained popularity.

As more earth-friendly weed killers hit the market every growing season, I wanted to chat with an expert about what they are and how they work.

## MEET THE EXPERT

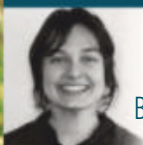

**HEATHER JOHNSON** IS THE  
LEAD HORTICULTURALIST AT  
BACHMAN'S FLORAL & GARDEN.

## CHOOSING THE RIGHT HERBICIDE



**CRABGRASS**



**CREEPING CHARLIE OR GROUND IVY**



**DANDELION**

Whatever the time of year or the conditions, you can use environmentally friendly ways to get rid of unwanted weeds or grass—from preemergent to post-emergent, selective and nonselective varieties.

Here are several important notes about products with environmentally friendly active ingredients. First, “A lot of the organic options are burn-down herbicides,” Johnson explains, “meaning the roots will remain intact and be able to regrow new shoots later.”

Second, Johnson stresses that “salt and vinegar can remain in the soil after killing the intended weeds, which can affect the growth of wanted plants in the area later on.”

To choose what’s best for your lawn or garden, Johnson advises to start by answering these three questions:

### WHAT TYPE OF WEEDS ARE YOU TRYING TO REMOVE?

Common weeds Johnson sees most homeowners struggling to control are dandelions, creeping Charlie and crabgrass. Both dandelions and creeping Charlie are broadleaf weeds. “If your lawn is overrun with these, it’s more likely that the health of the lawn is being impacted, and lawn care besides just weed removal needs to be done,” Johnson said.

The crabgrass problem is so widespread that companies have developed entire lines of herbicides to eliminate it. These toxic herbicides can be very effective when used correctly. However, Johnson said, “Same as with other weeds, if your lawn is overrun with crabgrass, then there are other health issues that need to be addressed.”

### HOW MANY WEEDS ARE YOU TARGETING?

In cases where weeds do not appear in large clusters or overtake the lawn, Johnson prefers hand weeding. “It allows me to dig up the entire weed without the potential of damaging the lawn,” she explains.

On the other hand, if the whole lawn is overrun with weeds, she suggests “reseeding along with testing the soil to understand the health of the grass and what nutrients may be needed to amend it.”

### WHEN ARE YOU APPLYING THE WEED KILLER?

“Some weeds are best handled preemergence, and some weeds are best handled post-emergence,” says Johnson. “Crabgrass can be handled pre- or post-emergence, with the most effective time being preemergence, in April or May, to avoid harming the lawn.” Broadleaf weeds are best handled post-emergence, “as long as it’s before they flower and spread.”

## EARTH-FRIENDLY PRODUCTS WORTH CHECKING OUT

### ESPOMA WEED PREVENTER PLUS LAWN FOOD

Espoma Organic Weed Preventer Plus Lawn Food is the best environmentally friendly weed care product for established lawns. This product is made of pure corn gluten meal, making it a safe product for children and pets to play on even immediately after application. In addition to inhibiting weed growth, the product also feeds the lawn, ensuring it stays green and healthy.

Johnson says organic and preemergent lawn products are “typically a fertilizer or germination inhibitor that won’t kill already established grass but will prevent any new plants from germinating.”

In order to get the best results, you need to apply the Espoma Organic Weed Preventer twice a year: once in early spring and again in early fall. A 25-lb. bag costs about \$60.



### A.D.I.O.S. SELECTIVE BIO-HERBICIDE

A.D.I.O.S. is becoming increasingly popular in parts of the United States where conventional herbicides are restricted. Salt, its active ingredient, is a selective herbicide that can be used against broadleaf weeds such as dandelions, creeping Charlie and thistles. A.D.I.O.S. meets all USDA organic standards and has been approved for use in commercial organic farming. But use sparingly, as Johnson has already said; the overuse of salt-based products can negatively affect the quality of soil in the long run. A 36-oz. spray bottle costs about \$39 at [natural-alternative.com](http://natural-alternative.com).



PRODUCT PHOTOS LEFT TO RIGHT: THE ESPOMA COMPANY, VIA HERBANATUR.COM, VIA GREENGOBBLER.COM

## MAKE YOUR OWN EARTH-FRIENDLY WEED KILLER

A mixture of vinegar, salt and dish soap can be used as a spot treatment for weeds, according to Johnson. Concentrated vinegar is a good choice because it's stronger than the household variety, usually at near 20% acetic acid. The salt and acetic acid present in vinegar cause the unwanted plants to dehydrate and wither, while dish soap enhances the effectiveness by breaking down the plant's outer layer (cuticle).

### DIY WEED KILLER

- 1 gallon of vinegar
- 1 oz. dish soap
- 1 cup of salt

To use this weed killer, mix the ingredients in a plastic spray bottle and spray directly on weeds. Apply the mixture on a sunny day when there is no wind. Because vinegar-based products are nonselective weed killers, they will harm all plants they are sprayed on. "If used in small amounts, this shouldn't affect the soil long term," Johnson said.

## GREEN GOBBLER 20% VINEGAR WEED KILLER

Green Gobbler 20% Vinegar Weed Killer is a potent, nonselective vinegar-based weed and grass killer. It is made from ethanol distilled from corn grain and concentrated vinegar containing four times the acetic acid of traditional household vinegar. A gallon costs about \$22.

Biodegradable and nontoxic, the OMRI-certified formula will safely remove all types of weeds from driveways, sidewalks and mulch beds.

Most environmentally friendly weed killers need to be sprayed directly on a growing weed so that the active ingredients can be taken up and distributed throughout the weed. So, Johnson suggests using "nonselective sprays such as this in an isolated area, where it's easy to target individual weeds."



## ELIMINATING WEEDS WITHOUT THE USE OF WEED KILLERS

If you're still feeling uneasy about using any sort of weed killer, environmentally friendly or not, other means are available to eliminate unwanted weeds and grasses.

Pouring boiling water on sidewalk, driveway or patio weeds is an effective method. The boiling water scalds the unwanted weed, and any water runoff will cool on the impervious surface before it reaches other plants.

To eradicate weeds from nonflammable areas such as cracks in sidewalks and gravel driveways, a propane torch is another effective alternative. Weeds growing on dry or combustible materials should never be torched, nor should poison ivy or other poisonous plants because their smoke can cause serious allergic reactions.

For large areas of your yard or between rows of vegetables in your planter boxes where no vegetation is wanted, consider solarizing or smothering the soil.

■ To solarize, place a transparent plastic tarp over the soil. The tarp prevents the soil from absorbing water, while at the same time heating the soil and ultimately killing all vegetation.

■ To smother weeds, place items such as layers of newspaper or old shower curtains on the soil to block both the sun and moisture.

One of the most effective ways to maintain a weed-free lawn is to follow a lawn care schedule. Johnson recommends using a lawn calendar that outlines when to do each lawn care maintenance task such as mowing, fertilizing and thatching. "Following those tips and hand-removing weeds when they are present is a good way to mitigate weeds without the use of any chemicals," she added.

If your lawn is more than 50% weeds, Johnson said it's best to reseed the whole lawn. 

# PEBBLE MOSAIC STEPPINGSTONES

COLLECT SOME RIVER ROCK AND MAKE YOUR OWN UNIQUE STEPPINGSTONE PATH

BY JEFF GORTON

**A**lice Medley loves to create works of art from the pebbles she collects. And she was generous enough to invite us into her garage workshop to show us how to make these beautiful pebble mosaic steppingstones. She uses a “dry-set” technique that makes it easy to change or adjust the pattern as you go without having to dig the stones out of wet mortar.

Medley also shared the plans for an ingenious reusable wooden mold that she purchased from a North Woods carpenter. The initial investment for this project—about \$80—covers the plywood, a bag of mortar, the pigment and the muriatic acid. That’s enough to make about seven or eight steppingstones. After that, each one will cost you less than a dollar.

## BUILD THE MOLD

A small sheet of ¾-in. plywood and some 1¼-in. screws are all you’ll need to build the mold. Cut out the pieces according to the Cutting List. Figure A shows how the parts go together. When you’re done, brush linseed or vegetable oil on the mold to protect it from moisture.

## COLLECT THE STONES

Medley collects her stones in northern Minnesota. You’ll find similar stones in most parts of the country. Look for them in river and creek beds or along lakeshores. Wherever you find them, make sure you have permission and that it’s legal to collect them. Another possible source is your local landscape supplier or wherever landscaping stone is sold.

Medley likes to sort them by color. She’s got buckets and cans full of red, gray, white, brown and speckled stones. Keeping them sorted makes it a lot easier for her to find the right one as she creates a pattern.

## MEET THE EXPERT



**ALICE MEDLEY** STARTED OUT USING MORE TRADITIONAL MOSAIC MATERIALS LIKE GLASS AND TILE FOR HER OUTDOOR ART PROJECTS. THEN SHE DISCOVERED SHE COULD MARRY HER LOVE OF STONES WITH HER LOVE OF MOSAICS.





## MATERIALS LIST

ITEM	QTY.
Collection of small stones	
Bag of Type S mortar mix	1
2' x 2' square piece of 6-mil poly	1
48" x 48" x 3/4" plywood	1
1 1/4" corrosion-resistant screws	40

**Optional items:** Mortar pigment or colored grout, muriatic acid and stone sealer

## CUTTING LIST

KEY	QTY.	DIMENSIONS	PART
A	1	18" x 18" x 3/4"	Subbase
B	1	12" x 12" x 3/4"	Base
C	12	2 1/4" x 15 3/4" x 3/4"	Frame
D	4	3 1/4" x 12 3/4" x 3/4"	Sides

### FIGURE A STEPPINGSTONE MOLD

FORMS 12" SQUARE STEPPINGSTONES

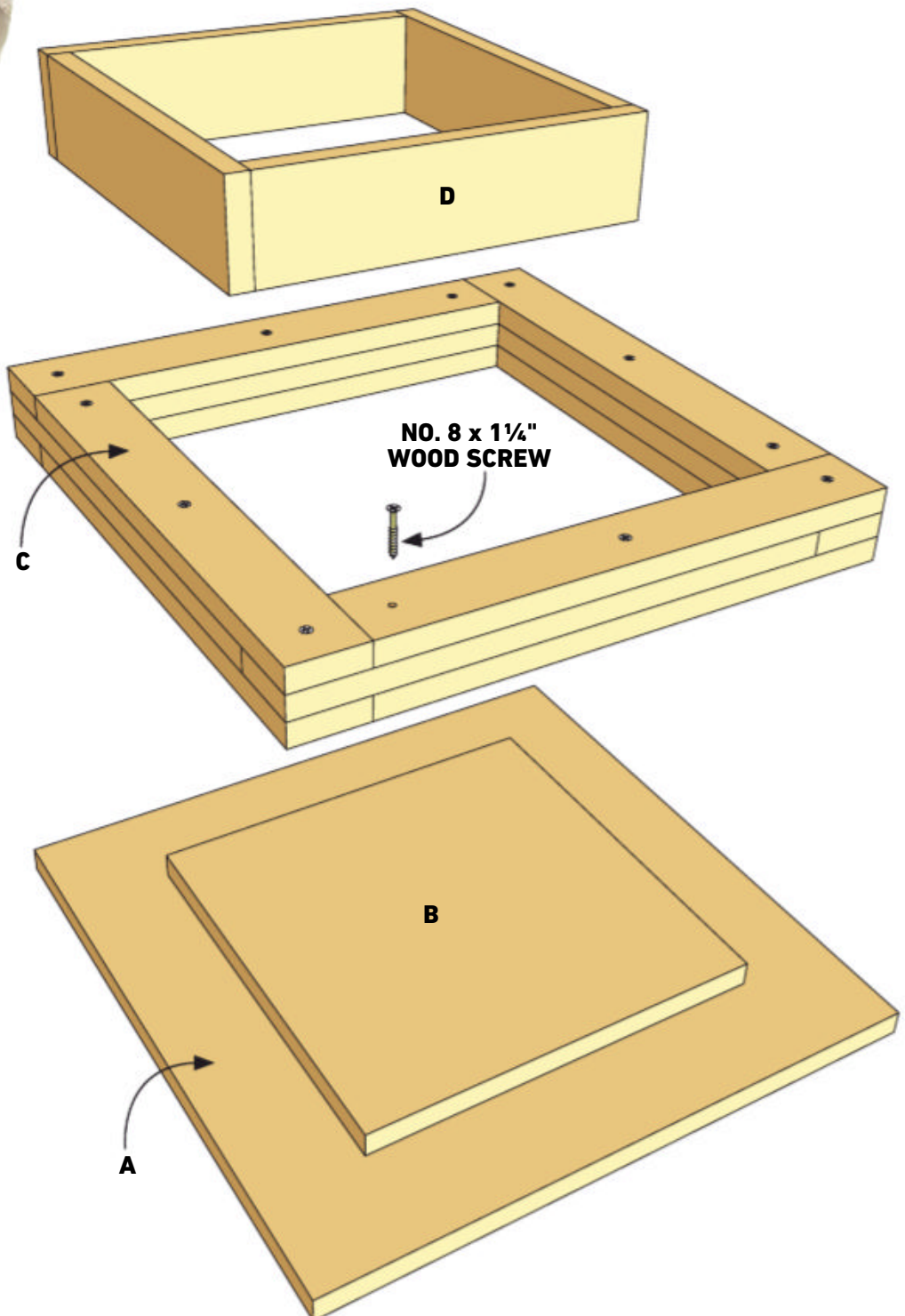



## 1 ASSEMBLE THE MOLD

This plywood mold goes together quickly and comes apart easily after the mortar hardens. You can use it again and again.



## 2 SPREAD DRY MORTAR IN THE FORM

Fill the plastic-lined form to about  $\frac{3}{4}$  in. from the top edge with dry Type S mortar. Level it with your gloved hand. It doesn't have to be perfectly flat.

## ASSEMBLE THE STEPPINGSTONE

Photos 1 – 4 show the assembly steps. Medley likes to add a little brown pigment to the dry Type S mortar mix to give the steppingstones a mellower look. You'll find cement pigments and Type S mortar at home centers and masonry suppliers. Or you can cheat as Medley does and just mix in a little colored ceramic tile grout. Make sure to wear rubber gloves to protect your skin from the mortar, which can cause skin burns.

You don't have to plan your pattern ahead of time. Medley says she has a design in mind and just starts arranging the stones. It's easier to start along the edges or in a corner and work toward the center, though. You'll have less fitting to do as you fill in the last few stones. Keep the stones close together and oriented with the long axis up and down.

While it's tempting, Medley cautions against laying a stone flat. She says it doesn't look as good as you think it will and is more likely to pop out later. When you're done tamping the stones into the dry mortar, inspect the spaces between the stones to see if there are spots that require more mortar. The stones should be buried at least halfway. Fill sparse areas with more mortar. Dust any dry mortar off the stones with a small brush.

The trickiest part of the process is wetting the mortar (Photo 5). We can't tell you exactly how much water to add, but it's better to sprinkle on several small doses



## 3 ARRANGE THE STONES IN A PATTERN

The only rule is to keep the stones close together so they touch and stand up and are not laid flat.

# DR® Lawn & Garden Edger

*Professional Edges Made EASY!*



- Stable 4 wheel design
- Curb Hop straddles a curb to make stable, precise cuts
- Pivoting blade for bevel cuts around garden borders
- Six cutting depths

**GoDRpower.com**

FREE Catalog!  
Call Toll-Free  
877-560-8902



# SPEEDWASH™ Pressure Washing System



**POWER BROOM** ▼  
cleans decks and driveways up to 4X faster!



**ULTRA-FAST. EASY to USE. BUILT to LAST.**

A complete pressure washing system from Generac that provides ALL the tools you need for every application.



**Up to 3200 PSI** for FAST, thorough cleaning!

◀ **POWERDIAL™ GUN** puts pressure control at your fingertips!

**CLEANING TOOLS** make washing anything FAST and EASY!

**LIMITED-TIME OFFER!\***

GET THE COMPLETE SYSTEM  
with FREE Cleaning Tools & FREE Shipping!

\*Visit online for offer details.

**GENERAC**

Order Today  
**GeneracSpeedWash.com**  
Toll Free 877-389-1880

★ **USA**  
ENGINEERED & BUILT  
Assembled in the USA  
using domestic and  
foreign parts.



Our monthly catalog has the tools, jigs and supplies you'll welcome in your shop.



EST 1928

**WOODCRAFT**

HELPING YOU MAKE WOOD WORK®

Scan To Receive  
A FREE Catalog.

To Find Your Local Woodcraft  
Store, Visit Woodcraft.com Or  
Call 800-225-1153.





#### **4 TAMP THE STONES TO LEVEL THE TOPS**

Lay a board across the stones and pound on it with a rubber mallet to embed the stones in the dry mortar and set the tops level with each other.



#### **6 TAP ON THE FORM**

Tap on the form with the mallet to remove air and help the water penetrate. Continue sprinkling and tapping until it seems like no more water will be absorbed by the mortar.



#### **7 PULL OFF THE MOLD**

Allow the steppingstone to harden and cure for at least two days. Then carefully flip it over and remove the mold. Clean it with water and then acid if needed.



#### **5 SPRINKLE THE STONE**

Adjust your spray wand or sprayer to the finest spray setting and sprinkle water over the completed steppingstone to wet the mortar.

than to get impatient and risk adding too much. Medley says the key is to alternate between wetting the top and tapping on the mold with the rubber mallet until it seems like not all of the water is being absorbed and bubbles quit appearing (Photo 6). Expect to spend about 45 minutes sprinkling and tapping the mold.

When the mortar is thoroughly dampened, set the completed steppingstone in a shady spot and cover it with a damp cloth and plastic. Wait at least 48 hours before removing the mold.

After you remove the mold from the steppingstone (Photo 7), brush the stone off to remove any loose mortar and rinse it with clear water. If, after drying, the embedded stones have a film of mortar on them, clean them off with muriatic acid diluted according to the instructions on the container. Remember, always add acid to water, not the other way around, and wear rubber gloves and safety glasses.

To enhance the color of the stones, coat them with stone sealer, which is available at home centers, online, or at masonry, landscape and tile suppliers. 

# BEST PRO TIPS

 EXPERT ADVICE FROM THE JOB SITE

## 7 BICYCLE MAINTENANCE TIPS

////////////////////  
KEEP YOUR BIKE IN TIPTOP SHAPE  
AND RIDE SAFE!

BY JAY CORK

**R**iding a bike is great fun, but owning one requires regular maintenance. If you want to avoid running to the bike shop every time something comes up, you will need at least a basic understanding of bicycle maintenance.

Joe Blegen hasn't owned a car in 14 years, relying solely on two wheels for his daily commutes. We caught up with Joe in his classroom where he teaches high school students valuable lessons on bicycle maintenance.

### PRERIDE CHECKLIST, OR "ABC"

Before every ride, go through the ABC checklist.

**A - Air.** Check the air pressure in your tires and adjust as needed. Check with a handheld gauge or use the gauge on the floor pump.

**B - Brakes.** With the bike tires on the ground, roll it forward and squeeze both brake levers—first the front and then the rear. There should be no slipping or squeaking. The brake lever should feel firm and responsive.

**C - Chain.** With the rear tire off the ground, check that the derailleur operates both up and down the gears and the chain is running smoothly.



**CHAIN-WEAR MEASURING TOOL**

## CHECK THE CHAIN FOR WEAR

Depending on the riding conditions, a typical multispeed chain needs to be replaced every 1,000 to 1,500 miles. A chain-wear measuring tool is inexpensive and useful for keeping track of your chain's condition.



**CHAIN LUBE**

## LUBRICATE YOUR CHAIN

Wipe off any dirt and debris, and drip the chain lube onto the links. Joe uses Finish Line Wet Lube in the classroom and on his own bikes. Don't use aerosol lubricants such as WD-40; they're not designed for bicycle lubrication. They evaporate quickly and won't provide long-term lubrication.



**FLOOR PUMP**

## KEEP YOUR TIRES HEALTHY

Keep your tires inflated within the suggested psi range. This protects the inner tube and keeps the tires in good shape. When storing the bike for long periods of time, hang it up. Keep in mind that tires and tubes lose air over time. Check them regularly.

### MEET THE EXPERT



**JOE BLEGEN** TEACHES BICYCLE MAINTENANCE AT OPEN WORLD LEARNING COMMUNITY IN ST. PAUL, MINNESOTA.

## SET THE SEAT HEIGHT

Make sure your seat is adjusted to fit your body on the bike. With the pedal crank at its lowest position, your leg should have about a 10-degree bend.



## CHANGING THE INNER TUBE

Removing the inner tube for repair or replacement is relatively straightforward, but here's a trick to avoid damaging it or your tire. Pry the tire bead away from the rim bead with your fingers. It might take some effort, but do this around the entire circumference of the wheel. It's tempting to use a screwdriver or pry bar for this step, but don't! One small slip, and you've got another hole to patch!

Once the old inner tube is out, tuck the new tube into the rim, starting at the stem. Seat the tire bead to the rim and inflate the tire slowly.

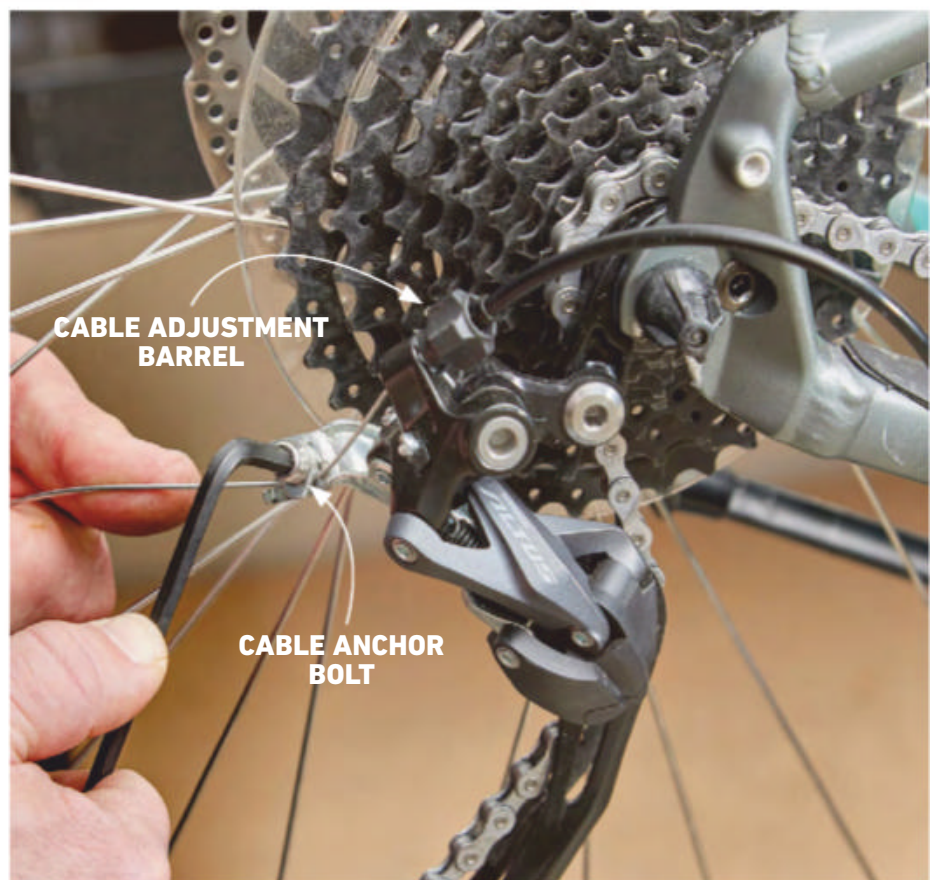

## ADJUST THE DERAILLEUR

Before adjusting the derailleur, ensure the cable is firmly seated. Adjust the action of the derailleur by loosening or tightening the cable barrel adjustment. Sometimes this is just a matter of trial and error—make an adjustment and try all the gears until the derailleur operates smoothly both up and down the gear cassette.



**CHECK YOUR BRAKE PADS**

Before you make any adjustments to your brakes, double-check that the wheel is firmly seated in the frame dropouts.

**RIM BRAKES**

Rim brake pads apply stopping force to the wheel rim and are the most common. Misaligned pads will wear at an angle (as shown here) and require replacement sooner—they will also suffer in performance. But in order to wear evenly, rim brake pads must be set at a slight angle to the rim. Joe uses a rubber band to help achieve this. He loops it around the leading end of the brake pad as he sets it in place. This creates just the right angle so that when the pad is engaged, it will flatten out against the rim and wear evenly.

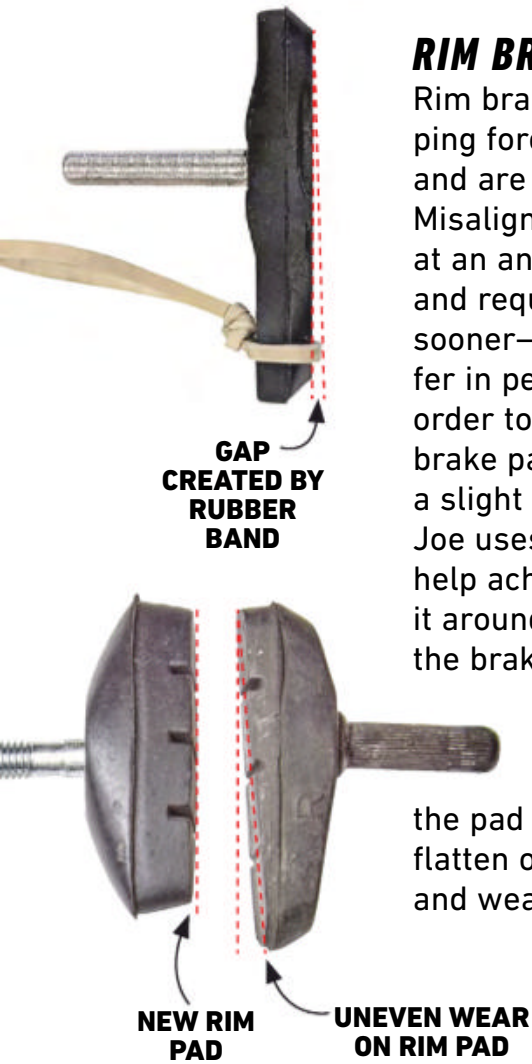

**WORN DISC BRAKE PAD**

**DISC BRAKES**

Disc brakes are becoming more popular and offer a step up in performance. Unlike rim brakes, they are located at the center of the wheel and are less affected by mud and water. Like all brake pads, they wear down. Replace them once they get to about 1 mm thick. Each type and manufacturer of disc brakes has a specific procedure for replacement. Consult your user's manual or talk to an expert at your local bike shop to learn what is required for yours.



**JOE'S TOOLS**

Here are Joe's essential tools for bike maintenance. You can buy them individually or as part of the Advanced Mechanic Tool Kit (\$340) at parktool.com.



**12" ADJUSTABLE WRENCH**  
(included in kit)

**METRIC HEX WRENCH SET**  
(included in kit)

**PHILLIPS AND FLAT-HEAD SCREWDRIVERS**  
(included in kit)

**FRAME PUMP**  
For easy tire pressure adjustments on the go, get this pump online for about \$25.

**TAPE MEASURE**  
(included in kit)

**CABLE CUTTER**  
(included in kit). This is used to cut brake and derailleur cables.

**CONE WRENCHES**

(included in kit). These wrenches allow for easy adjustment of hub bearings.

**ROTOR TRUING TOOL**

(included in kit). Joe uses this to straighten bent or damaged disc rotors.

**CHAIN-WEAR INDICATOR**

(included in kit). It helps you determine when your chain is due for replacement.

**PARK TOOL DUMMY HUB**

(included in kit). This holds the chain for cleaning when the wheel is not in the frame.

**TIRE LEVERS**

(included in kit). These are used for tire removal and installation.

**COMBO TOOL**

This chain whip (for removing cassettes) and 15 mm pedal wrench is included in the kit.

**PARK CHAIN TOOL**

(included in kit). This tool is used to remove chain rivets on chains without a master link.

**SHIMANO/SRAM CASSETTE LOCKRING REMOVER AND FREEWHEEL REMOVER**

Find it online for about \$10.

**PARK MASTER LINK PLIERS**

(included in kit). It lets you easily remove chain master links.

**VALVE CORE TOOL**

(included in kit). Used to remove or install tire valves.

**TORX AND HEX THREE-WAY WRENCHES**

(included in kit)

**SPOKE WRENCH**

(included in kit). Used for truing wheels and adjusting spoke tension.

**PATCH KIT**

This kit lets you fix a flat on the go. About \$15 online.

**CHAIN CLEANER**

(included in kit). This allows you to thoroughly clean the chain without removing it.

**MULTI-TOOL**

Bicycle multi-tools can handle many basic fixes when you're on the road.

# HOME CARE

**fh** MAINTENANCE & REPAIR | STORAGE & ORGANIZATION | HEALTH

## SETTING FENCE POSTS WITH EXPANDING FOAM

BY CHRIS DEZIEL

**A**ny fence builder knows you need strong posts for a strong fence, and that means backfilling the postholes with a dense, hard material other than dirt.

While a lot can be said for well-draining gravel, the material of choice has long been concrete mix. It's available in 50-lb. bags at any home center, and you usually need two bags per post. For a 100-ft. fence with 10 posts, that means lugging half a ton or more of concrete mix to the site, mixing it with water and shoveling it into the holes.

If a lightweight alternative to concrete performed just as well, many fence builders would choose it just to save their backs. Fence post-setting foam offers promise, but is it just as good as concrete?

We asked two experts who set posts with foam: Alex Capozzolo, co-founder of Brotherly Love Real Estate in Philadelphia, and Forrest McCall, co-owner of the home improvement blog "Mama Needs a Project."



*The use of expanding foam to set fence posts is a recent innovation. We asked two experts how foam compares with concrete for strength and usability.*

LEAD PHOTO: BENJAMIN RONDEL/GETTY IMAGES

## EXPANDING FOAM VS. CONCRETE

Post-setting foam is a two-part product, and before use, the parts must be mixed, which is done right in the bag. It's far lighter than concrete mix. Each bag contains enough material for a single post and weighs only 2 or 3 lbs.

Note: Unlike spray foam in an aerosol can, post-setting foam is a closed-cell formulation without air bubbles, making it more rigid. Most insulating foam is open cell.

### BRACING IS KEY

Whether you backfill with concrete or foam, you dig the same size postholes to the same depth, which should be one-third the length of the entire post for stability.

Backfilling is more difficult with foam. Because the foam expands when it sets, McCall says the post tends to move if not braced properly. Capozzolo adds that there's little time to fix leveling errors. Bracing is also recommended with concrete, but it isn't as critical because

concrete sets more slowly and provides plenty of time for readjustment.

### FOAM SAVES TIME

Post-setting foam hardens in minutes (15, according to Capozzolo) and cures fully in about two hours, much faster than concrete. This means you could backfill all your posts in the morning and continue building the fence in the afternoon—instead of waiting until the next day as you would with concrete.

### FOAM COSTS MORE

A single bag of Sika foam costs about \$16, at one bag per posthole. A bag of concrete mix costs about \$6, at two bags per posthole.

### FOAM ISN'T TEMPERATURE DEPENDENT

Unlike concrete, post-setting foam sets just as quickly in low temperatures as it does in higher ones. McCall also claims you can use foam in wet weather.

Concrete also sets in wet weather, but rainwater in the mixture can weaken it. That won't happen with foam because it isn't water soluble.

### CONCRETE IS STRONGER

Capozzolo and McCall agree foam isn't as strong as concrete. "For light-weight fences or locations that aren't subject to high winds, the expanded foam would be the ideal choice," Capozzolo says. "But if structural strength is a concern, then I'd recommend concrete."

Part of the problem is that foam contracts slightly during curing. That creates gaps between the foam and the post as well as the sides of the hole. You can strengthen loose posts by adding more foam and covering it with dirt to force the foam into gaps as it expands. But all in all, you're probably better off choosing concrete when you need strength.

## MISTAKES TO AVOID

Post-setting foam is relatively new on the market, and it's important to follow the instructions on the packaging. The mixing time is different for each product, and it's usually very short—15 to 30 seconds. Once mixed, you must be ready to use everything in the bag.

These are some common mistakes made by first-time users:

■ **Undersizing the hole:** A bag of foam fills a hole 8 in. in diameter by 36 in. deep. If the hole is too small, the foam will expand above ground and harden. This isn't a huge problem because you can easily trim it to ground level with a reciprocating saw. However, don't pour part of a bag into an undersized hole unless you have a plan for disposing of the rest, for example, letting it expand inside a bucket. If you just let it keep flowing onto the ground, you'll have a messy cleanup.

■ **Not being prepared:** In my experience setting 4 x 4 posts at a depth of 3 ft., it takes about a bag and a half per hole. Always have at least two holes ready.

■ **Failing to cut the bag open after mixing:** Every bag has a warning about this. If the foam can't get out, the bag will explode, showering everyone and everything in the vicinity with sticky foam. You do not want this stuff on your skin or clothes!

■ **Touching liquid foam with bare hands:** Like spray foam, post-setting foam is extremely difficult to remove from skin. Always wear gloves, long pants and long sleeves. When choosing your work clothes, know that you will very likely get foam on them, and it will never come off.

## BEST FOAM FOR SETTING POSTS

Some manufacturers call their product "expanding concrete" or "expanding composite," and some formulations are stronger than others. As you would expect, the stronger products are also more expensive.

**Sika PostFix** (\$16) sets in three minutes and cures in two hours. This popular foam can be used with

all types of posts, including wood, metal and vinyl.

At \$25, **Fast 2K Fence Post Mix and Concrete Alternative** is more expensive than Sika. Fast 2K comes in a 32.8-oz. bag that replaces 80 to 100 lbs. of concrete mix. It sets in 15 minutes in temperatures down to minus 20. The company sells a

similar product for deck posts.

The two parts of the **Secure Set 10-Post Kit** (\$90) come in separate containers, giving you the option of mixing smaller quantities when you need to strengthen an existing foam post footing. The kit is also less expensive. The cost per post is about \$7 cheaper than Sika.



## DON'T USE YOUR OVEN'S SELF-CLEANING FEATURE

In my more than 30 years as an appliance repair pro, the No. 1 call I get for ovens is to make them work again after the caller used the self-cleaning feature. An oven that self-cleans is appealing, but the use of the feature can result in expensive repairs.

A self-cleaning oven incinerates the spills in your oven and turns them into ashes. It does this by bringing the oven's interior temperature to almost 1,000 degrees for three to five hours. That much heat can damage oven components. These are the most at risk:

- The high-limit switch is the component most likely to fail. When the oven gets that hot, it can break the power connection to the elements or igniters, so none of the oven's heating features will work, and you'll likely hear the cooling fan kick on when you use the oven. Replacing the switch is a pro fix that costs about \$200.
- The door lock remains locked past the two-hour cooling time. You need a pro to fix it (\$200).
- Melted bake, broil or convection elements. Replacement requires a pro and costs \$200 to \$300.
- Broken relay board or controller. The super-high heat that is vented during self-cleaning damages the circuit board. The fix requires a pro and can cost \$300 to \$600.
- Melted knobs. Easy to replace. Pretty inexpensive and easy to DIY.
- Burst oven lightbulb.

Inexpensive and easy to DIY.

Bottom line: It isn't safe to self-clean an oven. Here are a few of the dangers associated with using the self-cleaning feature:

- Carbon monoxide is released as the oven dirt and grease are incinerated. The dirtier the oven, the more CO is released. Your oven does not vent this dangerous gas outside. Instead, the CO gas goes into your kitchen. There currently is no clinical evidence regarding how much CO is released during the self-clean cycle.

- Touching the oven during the four-to-six-hour self-cleaning cycle can cause severe burns. Most oven user manuals warn that small children and pets must be kept out of the kitchen during the self-cleaning cycle.

- The oven could catch on fire and cause a house fire.

However, a significant benefit of self-cleaning ovens is that they require much more insulation around the oven chamber, which makes them more efficient.

In fact, a self-cleaning oven costs about \$100 more than a regular oven, but over four to five years of baking, that \$100 should be made up from energy savings.

To clean your oven without using the self-clean feature (or harsh chemicals), use items you already have at home such as baking soda and vinegar. You can also steam-clean your oven.

SCOTT FLINT CONTRIBUTING WRITER

## 4 OSCILLATING MULTITool BLADES YOU SHOULD OWN

Check out these attachment blades that can unlock the true potential of your oscillating multitool. You can find all four of these attachments online.



### ANGLE BLADE

On rare occasions, an oscillating blade won't go where you need it to. This angle blade from Imperial Blades just might be the solution.

### CAULK KNIFE

It quickly slices away old caulk and can cut even faster as it heats up due to friction. This blade can beat up nearby surfaces, so practice in an inconspicuous area first.



### DOUBLE-SIDED BLADE

When this Spyder blade becomes too dull to use, you don't toss it in the trash. Instead, just flip it around and you get fresh, sharp teeth on the other side.

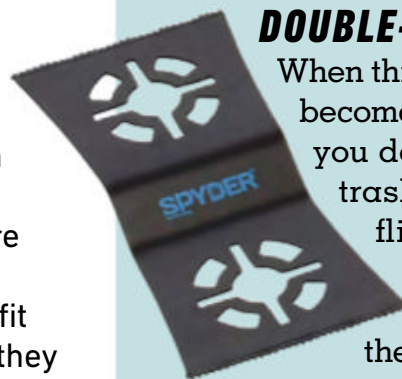

### ELECTRICAL BOX CUTOUT BLADE

This "blade" is actually four blades that simultaneously cut a perfect junction box hole in drywall (just don't expect it to cut wood). Other sizes are also available.



GARY WENTZ CONTRIBUTING WRITER 

# ALL-NEW! DR® ELECTRIC ZERO-TURN LAWN MOWERS

## Mow up to 5 ACRES on a single charge!

★ USA

ENGINEERED AND BUILT

Assembled in the USA  
using domestic and  
foreign parts.



- Professional quality, 3-blade mowing deck (48" or 60" cutting width)
- No gas, no oil, no emissions, less noise, and operational savings versus gas
- Accepts up to 3 E-Series Battery Packs (2.5 kWh each) so user can customize runtime to property size



SALE!

**FREE  
SHIPPING**

SOME LIMITATIONS APPLY

**DRmowers.com**

Request your **FREE** Product Catalog!

Toll Free: 877-330-9753



PROMOTION

# WORK+SHOP

## KITCHEN & BATH

NEOPERL, Inc. designs and manufactures water saving products that enhance the stream quality and control the flow rate of faucets and shower products.

[Neoperl.com](http://Neoperl.com)

## OUTDOOR/LAWN & GARDEN

Want a great lawn?

Start with a better grass – Amazoy Zoysia Grass! Learn more:

**1.410.756.2311 | [Zoysiafarms.com](http://Zoysiafarms.com)**

## TOOLS

Since 1928 Woodcraft has been outfitting woodworkers and their shops with everything woodworkers want. Find the best tools, or the most amazing wood for your next project.

[Woodcraft.com/catalog](http://Woodcraft.com/catalog)

NEOPERL®

flow, stop and go®



Zoysia Farms  
NURSERIES



WOODCRAFT®



Grizzly  
Industrial



Grizzly Industrial, Inc. Purveyors of Fine Machinery since 1983.

**1.800.523.4777 | [Grizzly.com](http://Grizzly.com)**



## DO YOU CRAVE MORE FAMILY HANDYMAN?

Get our best tips and hints sent to your inbox. Sign up at [familyhandyman.com/newsletter/](http://familyhandyman.com/newsletter/)

### GOT A DIY QUESTION?

Finding the answers is easy at [familyhandyman.com](http://familyhandyman.com). Click on the three bars at the top left of the page and then search your topic to get expert step-by-step help with your projects.

### GOT A HANDY HINT OR TIP FOR US?

To share your idea with us, submit a copy of your original contribution, including photos and/or sketches, by email to:

[submissions@familyhandyman.com](mailto:submissions@familyhandyman.com)

Or mail to: *Family Handyman*, 1610 N. Second St., Suite 102, Milwaukee, WI 53212

Please include your name, mailing address and email address if you have one, and indicate to which department you are submitting. We reserve the right to publish your submission in any appropriate department, or elsewhere. Contributions will not be acknowledged or returned.

### RIGHTS

By submitting material to us, you grant Home Service Publications, Inc., its parent company subsidiaries, affiliates, partners and licensees worldwide use of the material without time limitation, including the right to use your name and city/state/province in connection with any such use. We reserve the right to modify, reproduce and distribute your material in any medium (now or hereafter existing) and in any manner or appropriate place, including but not limited to magazines, promotional merchandise and marketing, and other related materials.

**FAMILY HANDYMAN**® ISSN: 0014-7230, USPS: 515-930. Vol. 73, No. 2, 624th Edition. Published 7 times per year: March, April/May, June, July/August, September, October/November, December/January/February by Home Service Publications, Inc., 1610 N. Second St., Suite 102, Milwaukee, WI 53212. We may also occasionally publish extra issues and special issues (which count as two in a subscription). Periodicals postage paid at Milwaukee, WI, and at additional mailing offices. **POSTMASTER:** Send address changes to [customercare@familyhandyman.com](mailto:customercare@familyhandyman.com), visit [familyhandyman.com/customercare](http://familyhandyman.com/customercare) or write to *Family Handyman* Customer Care, PO Box 6099, Harlan, IA 51593-1599. **SUBSCRIPTIONS:** In the U.S.A., its territories and possessions, \$24 for one year (7 issues). For countries outside the U.S.A., subscriptions are \$28.97 per year in American currency. Canadian GST registration number R123771891. CPM agreement number 40065693. **Printed in the U.S.A.** Copyright ©2023 Home Service Publications, Inc. All rights reserved. Unauthorized reproduction, in any manner, is prohibited. *Family Handyman*, Handy Hints, Great Goofs and Build It. Fix It. Live It! are registered trademarks of Trusted Media Brands, Inc. Wordless Workshop, Workshop Tips and  are trademarks of Trusted Media Brands, Inc. **SUBSCRIBERS:** If the U.S. Postal Service alerts us that your magazine is undeliverable, we have no further obligation unless we receive a new address within one year. **CONSUMER INFORMATION:** *Family Handyman* may share information about you with third parties for the purpose of offering products and services that may interest you. If you would rather not receive such offers via postal mail, please write to: *Family Handyman* Customer Mailing List, PO Box 3122, Harlan, IA 51593-0188. You can also visit [www.tmbi.com/preference-center](http://www.tmbi.com/preference-center) to manage your preferences and opt out of receiving such offers via email. Please see our Privacy Policy at [www.tmbi.com/privacy-policy](http://www.tmbi.com/privacy-policy)

By submitting material to us, you represent and warrant that you have full authority to grant the rights set forth above and that your material will not, in whole or in part, infringe the intellectual property rights, rights of privacy or publicity, or any other rights of any third party. You further represent and warrant that you have attained the legal age of majority in your state/province (18 in most states/provinces). If you're a minor under the law of your state/province, your parent or guardian must submit on your behalf.

### CUSTOMER CARE

For subscriptions, payments, account info, renewals, gifts and other inquiries, email: [customercare@familyhandyman.com](mailto:customercare@familyhandyman.com) or visit: [familyhandyman.com/customercare](http://familyhandyman.com/customercare)

You can also write to: *Family Handyman* Customer Care, PO Box 6099, Harlan, IA 51593-1599

Single copies of past issues are available for purchase at our affiliate, [shop.tasteofhome.com](http://shop.tasteofhome.com). The cost is the cover price (\$5.99) plus \$1 shipping and handling for each copy.

### COMMENTS AND SUGGESTIONS

We welcome your ideas and opinions. Write to: The Editor, *Family Handyman*, 1610 N. Second St., Suite 102, Milwaukee, WI 53212. Email: [feedback@familyhandyman.com](mailto:feedback@familyhandyman.com)

### TO REQUEST PERMISSION TO REPRINT

If you'd like permission to reprint any material that appears in *Family Handyman*, please write to us with the nature of your request. Please include as much detail as possible relating to your intended use of the material and specify the issue date and page number (or URL, as applicable) where the material originally appeared. Please send an email to [permissions@tmbi.com](mailto:permissions@tmbi.com)

# family handyman

## EDITORIAL

Chief Content Officer, Home & Garden: **Jeanne Sidner**  
 Content Director: **Amy Novak**  
 Creative Director: **Raeann Thompson**  
 Deputy Editor, Projects: **Brad Holden**  
 Deputy Editor, Digital: **Ryan Van Bibber**  
 Deputy Editor, Contributors & Community: **Berit Thorkelson**  
 Senior Editors: **Donna Bierbach**, **Harrison Kral**, **Mike Berner**, **Jay Cork**, **Ethan O'Donnell**, **Alex Shoemaker**, **Mary Flanagan**, **Rebecca Wright-Brown**, **Joe Cruz**, **Dulcie Shoener**, **Ann Walter**, **Sara Strauss**, **Kara Dennison**, **Elizabeth Pollock Bruch**, **Pat Borzi**, **Peggy McDermott**, **Jennifer Mahoney**, **Mariah Tuggle**, **Tom Fenga**, **Kellen Berg**, **Michelle Bombard**  
 Contributing Copy Editor: **Pat Borzi**  
 Editorial Services Associate: **Peggy McDermott**  
 Art Director: **Jennifer Mahoney**  
 Junior Art Director: **Mariah Tuggle**  
 Senior Photographer: **Tom Fenga**  
 Senior Video Producer: **Kellen Berg**  
 Senior Manager, New Digital Products: **Michelle Bombard**

## BUSINESS

EVP, Media Sales: **Lora Gier**  
 VP, U.S. Licensing: **Pete Holfelder Jr.**  
 VP, Sales – East: **Cory Rotkel**  
 VP, Integrated Sales: **John Dyckman**  
 VP, Marketing: **Alison Miller**  
 Midwest Advertising Director: **Kim Krubeck Hinrichs**  
 West Coast Advertising Director: **Isabella Carrado**  
 Director, Sales Analytics & Operations: **Gisele Myer**  
 New York, 646-518-4215  
 Midwest, 312-540-4824  
 Classified & Small Display Ads: **Kari Nestor**, **Rachel Hirsch**, **Liz Spitaleri**, **Monica Weiss**, **Isabella von der Linden**, **Kathy West**, **Jennifer Izzo**, **Nancy Forman**  
 Advertising Coordinator: **Selena Cohen**  
 Production Manager: **Bonnie J. Myers**  
 VP, Insights Lab: **Babette Lazarus**  
 Associate Director, Research: **Sebastian Rodriguez**  
**TRUSTED MEDIA BRANDS, INC.**  
 President & Chief Executive Officer: **Bonnie Kintzer**  
 President, Digital: **Vince Errico**  
 Chief Content Officer: **Beth Tomkiw**  
 Chief Financial Officer: **Kanuj Malhotra**  
 Chief Marketing Officer: **Michelle Korchinski-Ogden**  
 Chief Revenue Officer: **Rose Ferraro**  
 Chief People Officer: **Jennifer Tyrrell**  
 Chief Technology Officer: **Nick Contardo**  
 Chief Product Officer: **Emily Christner**  
 SVP, SEO, Partnerships & Digital Performance: **Jen Keller**  
 SVP, General Counsel: **Mark Sirota**  
 SVP, Finance: **Patrick Hayward**  
 EVP, Global Content Operations: **Christina Smith**  
 VP, Associate General Counsel/Chief Privacy Officer: **Paul Gillow**  
 VP, Benefits & Compensation: **Heather Schwartz**  
 VP, Consumer Marketing: **Linda Alexander**  
 VP, Consumer Marketing Planning: **Jim Woods**  
 VP, Data Science & Modeling: **Tom Argiriou**  
 VP, Operations: **Michael Garzone**  
 Content Director, Strategy & Performance: **Nicole Doster**

## EDITORIAL OFFICE

1610 N. Second St., Suite 102, Milwaukee, WI 53212



**Anderson™**  
**Super Space Saving Bed**

Made in USA

T.V. Holder  
 Lit Headboard  
 Side Tables  
 Has Up to **26** Drawers  
 4 Ft. Long End Drawers

**Custom Built in 2 Days**  
**You Choose From 30 Options**

**World's Best Bed!** Eliminates dressers, box spring, wobbly bed frame & dust. **Fits in very small rooms.** Top quality materials. You custom design your bed from 30 options. Ready to ship UPS in two days. It's a complete bedroom suite in one piece, **plus, we also make the world's most comfortable mattress.**

**Solid wood, ball-bearing slides, 1000 Lb. Cap. 50 Yr. Warranty**

**Call: 800 851-9213**  
**www.ultimatebed.com**

**TOUGH Jobs Made EASY!**

**NEW Hydro-Static Drive!**

StruckCorp.com/fhm

The NEW sub-compact, easy to use **MAGNATRAC® RT1150**, is the perfect solution for homeowners that need to tackle all those tough jobs! Land-  
 scape your property, plow snow, skid logs for firewood, make gardens, make food plots and trails...even dig a small pond!

- ✓ **SAVE MONEY!** Stop paying others to do jobs you could easily do yourself.
- ✓ **EASY TO USE!** No shifting gears, just instant power to forward and reverse.
- ✓ **MADE IN THE USA!** Quality craftsmanship, by American workers!

**Get Your FREE Info Kit!**

**1-262-624-0424**  
 Mention Promo Code: FHM423

**STRUCK** Get Your **FREE** Info Kit!

**Now! Complete National Park Quarter Set Only \$19.95!**

**Don't miss out!** The final coin has been released and quantities are limited for these **Uncirculated Complete 56-Coin sets!** The first coin in this set was issued in 2010.

- **FREE** Shipping!
- **FREE** Gift: Uncirculated Lincoln Shield Cent

You'll also receive a handpicked trial selection of fascinating coins from our **No-Obligation Coins-on-Approval Service**, from which you may purchase any or none of the coins – return balance in 15 days – with option to cancel at any time.

**Final Issue**

**Personalize Your Folder!**

- Add a name or special message
- Embossed in gold-colored foil

**SAVE 50%**  
 John Sample  
 Made in USA

**Special Offer for New Customers Only**  
 **YES** Please send me the following:

QTY	DESCRIPTION	PRICE	TOTAL
	56-Coin Collector's Set (limit 3)	\$19.95	
	Display Folder	\$4.95	
	Personalize my folder for \$1.97 each (Reg. \$3.95)*		
1	Uncirculated Lincoln "Shield" Cent	<b>FREE!</b>	
	Shipping	<b>FREE!</b>	
	Sales Tax	<b>FREE!</b>	
<b>ORDER MUST BE RECEIVED WITHIN 30 DAYS</b>		<b>TOTAL</b>	\$

Write your personalization here, limited to 30 characters including spaces

ACTUAL LETTERING WILL APPEAR ON ONE LINE. Folder sold separately. Personalized Items cannot be returned.

Payment Method:  Check payable to Littleton Coin Co.  
 VISA  MasterCard  American Express  Discover

Card #: \_\_\_\_\_ Exp. Date: \_\_\_\_/\_\_\_\_/\_\_\_\_

Name \_\_\_\_\_  
 Address \_\_\_\_\_ Apt# \_\_\_\_\_  
 City \_\_\_\_\_ State \_\_\_\_\_ Zip \_\_\_\_\_  
 E-Mail \_\_\_\_\_

Mail to: Littleton Coin Company  
**Offer Code: 25H400**  
 1309 Mt. Eustis Rd Littleton, NH 03561-3737

**Littleton Coin Company®**  
 Serving Collectors Since 1945  
**Offer Code: 25H400**

**Mail Coupon Today!**  
**For Faster Service Visit:**  
**LittletonCoin.com/Specials**

©2023 LCC, Inc. Common Obverse Actual Size

# The Workshop

**Most Items In Stock**

**15 Snow Guard Models**



**Adhesive and Mechanical Mounting**  
Polycarbonate and Metal Snow Guards Available

**SnoBar & ColorBar Mill Finish or Powder Coated**

**6' BAR KITS AVAILABLE FOR QUICK SHIPPING!**  
Year Round Solution

**ALL NEW SNOCLEAT NOW IN STOCK!**



**ALUMINUM SEAM MOUNTED SNOW GUARDS**  
Also Available For R-Panel & 2.67 Corrugated Roofing

**Mounts Over The Roof Peak**



**WORK SAFELY ON YOUR ROOF!**

**Tie-Off Point For Steep-Slope Roofs**  
The RidgePro Roof Anchor - Roofing Safety Tool

**STANDING SEAM ROOF CLAMP**  
ROOFCLAMP™



**ATTACH ANYTHING TO A METAL ROOF**



**Chimney & Vent Pipe Protection**  
Mounting Kits Available For Standing Seam Roofs

**SN BLOX JAX**  
www.SNOJAX.com  
Phone: 1-800-766-5291  
671 Willow Street Lemoyne, PA 17043

**Oneida Air Systems** *The Industry Leader in Dust Collection*



*"WOW! My wet/dry vac is as clean as a whistle."*  
- Amazonguru

**NEW SEE-THRU BUCKET**

To Learn More About the Dust Deputy® 2.5 Deluxe



oneida-air.com Made in the USA since 1993 

**STAY SAFE IN THE HOME YOU LOVE.**

**DID YOU KNOW?**

- ✓ 1 in 4 seniors will fall this year.\*
- ✓ Most falls happen on the stairs.
- ✓ Acorn Stairlifts has the best solution to stay safe on the stairs.



**GET \$250 OFF\*\* YOUR PURCHASE OF AN ACORN STAIRLIFT!**

**PLUS, RECEIVE A FREE STAIRLIFT BUYING GUIDE & DVD JUST FOR CALLING!**

**1-866-234-2906**

\*According to the CDC. \*\*Not valid on previous purchases. Not valid on refurbished models. Only valid towards purchase of a NEW Acorn Stairlift directly from the manufacturer. \$250 discount will be applied to new orders. Please mention this ad when calling, AZ ROC 278722, CA 942619, MN LC670698, OK 50110, OR CCB 198506, RI 88, WA ACORNSI8940B, WV WV049654, MA HIC169936, NJ 13VH07752300, PA PA101967, CT ELV 0425003-R5, AK 134057.



**SHELVES THAT SLIDE**

- Custom Made for Your Cabinets
- Kitchens • Pantry • Bathrooms
- Limited Lifetime Warranty
- Baltic Birch Construction
- 100 Pound Capacity

1-800-598-7390  
www.shelvesthatslide.com  
Order On-Line

Custom pull out shelves and Kitchen cabinet accessories



Call or email for a free catalog

# Sea Eagle® SE370 Kayak

12'6" Inflatable SE370 Everything Package

Includes *Everything* you need to get out on the water! Including 2 life jackets and an electric pump!

**All for just \$399** (plus applicable sales tax).

- ✓ Paddle flat water or up to Class III rapids
- ✓ 1 open/close floor drain
- ✓ Can be paddled by 1 or 2
- ✓ Holds up to 650 lbs.
- ✓ Weighs just 32 lbs.
- ✓ Multiple air compartments for maximum safety
- ✓ Packs down to just 31" x 19" x 8" to fit in small spaces

**SEA EAGLE.com**

1-800-944-7496 for a FREE catalog  
Dept. FH043B  
19 N Columbia St., Ste 1, Port Jefferson, NY 11777

# Boost Testosterone

## Drive & Peak Performance



**EXPIRES 06/30/23 MANUFACTURERS COUPON**

**SAVE \$3.00**  
ANY IRWIN NATURALS PRODUCT

Consumer: Redeemable at retail locations only. Not valid for online or mail-order purchases. Retailer: Irwin Naturals will reimburse you for the face value plus 8 (cents) handling provided it is returned by a consumer at the time of purchase on the brand specified. Coupons not properly redeemed will be void and held. Reproduction by any party by any means is expressly prohibited. Any other use constitutes fraud. Irwin Naturals reserves the right to deny reimbursement (due to misrepresentation activity) and/or request proof of purchase for coupons submitted. Mail to: CMS Dept. 10563, Irwin Naturals, 801 Union Pacific Blvd Ste 5, Laredo, TX 78045-9475. Cash value: .001 (cents). Void where taxed or restricted. ONE COUPON PER PURCHASE. Not valid for mail order/websites. Retail only.

0710363-015295

**\$3 COUPON** redeemable at all Drug, Grocery and Health Food stores Nationwide

These statements have not been evaluated by the Food & Drug Administration. This product is not intended to diagnose, treat, cure or prevent any disease.

# GREAT GOOFS



LAUGHS AND LESSONS FROM OUR READERS



## THE PRESSURE IS KILLING ME

The soffit by the garage had come loose, so I hooked up my nail gun to the air compressor, got on a stepladder and nailed the piece back up. While I was at it, I decided to caulk the joint as well. I put a new tube of caulk in my air-driven caulk gun, got on the ladder and placed the nozzle in the corner of the gable.

I pulled the trigger. In about one microsecond

the tube exploded and covered me, the garage, the shrubs and my car with caulk. I had forgotten to readjust the air-pressure setting when I changed from my nail gun to the caulk gun, and I hit that tube of caulk with about 100 psi instead of what should have been about 20 psi. I can tell you one thing: Caulk is a bear to get out of your hair.

JOHN B. VOLLMER

## TOTALLY HOSED

When we first moved into our new house, most of our stuff hadn't been delivered yet, but we did have our water bed and decided to set it up. When it was ready to be filled, I realized we didn't have our garden hoses. Luckily, the previous owner had left one behind, so I ran it out the window and went outside to hook it up to the outdoor faucet.

I turned on the faucet and paused to meet my new neighbor. When I finally went inside, I discovered I had watered my new bedroom with a soaker hose!

JOSHUA KOCH



## THE SALAD BAR SURE HAS GONE DOWNHILL

*Deer are frequent diners in our yard, and they had nibbled overnight on a few of our new shrubs. I went to the garage and grabbed the Liquid Fence deer repellent. I gave the shrubs a quick spray, and while I was out, I sprayed other areas the deer like to munch on.*

*After a few days, I noticed that some plants looked a bit worn. We'd had a drought earlier, but I was sure that was past. I kept watching, and the plants continued to decline. That's when I realized I had grabbed Roundup instead of Liquid Fence. Even though I had labeled the sprayers, I was so used to grabbing the Liquid Fence sprayer that I forgot there were two.*

*After two weeks, some plants were gone. A few shrubs had lost leaves but had buds. The grass died in various spots, and there were swaths carved out of the perennial garden.*

*The sprayers are now labeled more clearly!*

CHARLES WOOLEVER

ILLUSTRATIONS: STEVE BJÖRKMAN



gdefy®

# EXPERIENCE THE *Miracle*



"After suffering with extreme foot pain for months, I can finally walk again with no pain. **They are truly miracle shoes!**" – Carol D.

See more miracle testimonials at [gdefy.com](http://gdefy.com)

Enjoy the **benefits** of exercise without harmful impact on your joints!

- ✓ Renewed Energy
- ✓ Improved Posture
- ✓ Maximum Protection
- ✓ Relieve Pain

**60 DAY "TRY DEFY" MONEY-BACK GUARANTEE!**

**Mighty Walk \$145** MED/WIDE/X-WIDE AVAILABLE

This product is not intended to treat, cure or prevent any disease.

Women



**TB9024FLP**  
Black

**TB9024FGP**  
Gray/Salmon

**TB9024FGS**  
Gray

Men



**TB9024MBL**  
Black/Silver

**TB9024MLU**  
Black/Blue

**TB9024MGS**  
Gray

**\$20 OFF** orders of \$100 or more

Promo Code **PH2DQS5**

Expires July 31, 2023

FREE EXCHANGES & RETURNS

**800-429-0039** · [www.gdefy.com](http://www.gdefy.com)

Plus Free Corrective Fit Orthotics  
for plantar fasciitis, stability & support!



VersoShock® U.S Patent #US8,555,526 B2. \$20 off applies to orders of \$100 or more for a limited time. Cannot be combined with other offers. Free Corrective Fit orthotics not included with sandal purchase. Additional sales taxes may apply. Shoes must be returned within 60 days in like-new condition for full refund or exchange. Credit card authorization required. See website for complete details.

Progressive Casualty Ins. Co. & affiliates. Coverage features subject to policy terms, and may not be available in all states or for all vehicles. Additional charge and deductible apply. Prices vary based on how you buy.

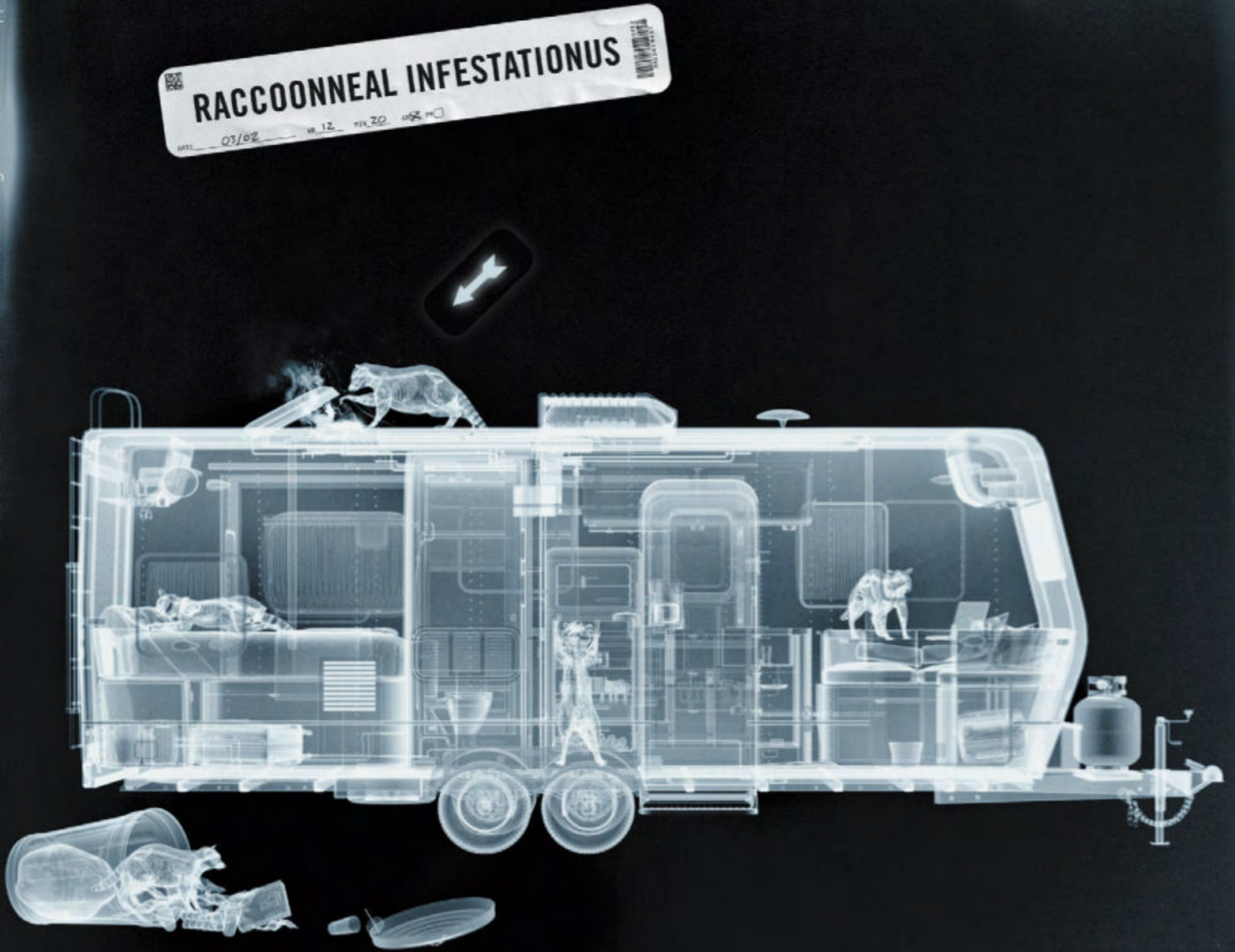

**Translation: Your RV that sleeps four is now home to a family of 12.**

But no matter the diagnosis, we're here for you with optional Pest Damage Protection<sup>SM</sup>. Get coverage you can really see with Progressive.

1-800-PROGRESSIVE | PROGRESSIVE.COM

**PROGRESSIVE**